

ANGELIC GOLF INC.

ANGELIC PREMIERE RESIDENCES BLDG. MARINA ST.
MALABANIAS ANGELES CITY. 2009

EMAIL: Charles@angelicgolf.com/Curtis@angelicgolf.com

PHONE: +63 0917-106-5025 / +6309275253797



Charles Wilkins

DIRECTOR
ANGELIC GOLF INC.



+63 917-106-5025



charles@angelicgolf.com



<https://angelicgolf.com>



Angelic Premiere Residences, GF
Blk 8 Lot 3 Marina St. Cor. Josefa St.
Malabanas Angeles City 2009



ANGELIC
GOLF CENTER

DRIVING RANGE EQUIPMENT
MATS, BALL DISPENSER, BALL WASHER
AUTOMATIC BALL MANAGEMENT SYSTEMS
GOLF SIMULATORS



Curtis Garner

ANGELIC GOLF INC.



+63 927 525 3797



curtis@angelicgolf.com



<https://angelicgolf.com>



Angelic Premiere Residences, GF
Blk 8 Lot 3 Marina St. Cor. Josefa St.
Malabanas Angeles City 2009



ANGELIC
GOLF CENTER

DRIVING RANGE EQUIPMENT
MATS, BALL DISPENSER, BALL WASHER
AUTOMATIC BALL MANAGEMENT SYSTEMS
GOLF SIMULATORS

TABLE OF CONTENTS

DRIVING RANGE EQUIPMENTS & SUPPLIES

1-3	Ball Picker
4	Ball Washer
5-8	Mats
9	Rubber Tees, Ball Trays & Stackers
10	Golf Balls
11	Tee Divider
12	Ball Keeper
13-16	Bag Racks
17-18	Range Markers & Target Nets
19	Practice Flags & Flagsticks
20	Practice Cups & Flagsticks
21	Synthetic Turfs
22	Practice Net

GOLF COURSE SUPPLIES & ACCESSORIES

23	Rubber Mats
24	Spike Air Cleaners

RECYCLED PLASTIC PRODUCTS

25	New Products
26	Spike Air Cleaners

TEE PRODUCTS

27	Club Washers
----	--------------

28	Club Racks
29	Benches

COURSE MARKINGS & TOOLS

30-47	Signage
48-49	Easel Signs & Clocks
50	Podiums
51	Water Coolers
52-53	Ball Washer
54	Waster Mat Trash Bin & Parts
55	Ball Washer Accessories
56-58	Trash Containers
59-63	Divot Mix Storage
64	Sand Dispenser & Scorecard Caddy
65	Spike & Shoe Cleaners
66-71	Tee Markers
72	Tee Signs

FAIRWAY PRODUCTS

73-74	Bunker Rakes
75-79	Yardage Markers
80	Ropes , Rope Stakes & Safety Net

GREEN PRODUCTS

81-84	Flags
85	Placement Flags & Markers

86-89	Flagsticks
90	Smarty & Smartsticks
91	Laser Link Rangefinders
92	Putting Cups
93	Target Ring & Green Tools

TOOLS

94-95	Hole Cutter & Driving Range Supplies
96	Green Meter & Dew Whippers
97	Turf Repairer & Aerators
98	Turf Plugger & Soil Samplers
99	Drag Mat, Brush & Levelawn
100	Shovels & Rakes

OTHERS

101	Head Covers, Bibs & Rainsuits
102	Sand Bags, Bag Cover & Hand Scoops
103	Bag Tags
104-105	Divot tools & Ball Marks
106	Wooden Tees
107	Score Card Holders & Pencils



RANGE PICKERS

- New design of golf ball pickers in series.
- Conform to any golf ground terrain and designed to minimize damage to turf and range balls.
- Each picker frame and draw bar are powder coated finish to resist rust and corrosion.
- Most durable and flexible composite plastic disc will not break, crack or chip.

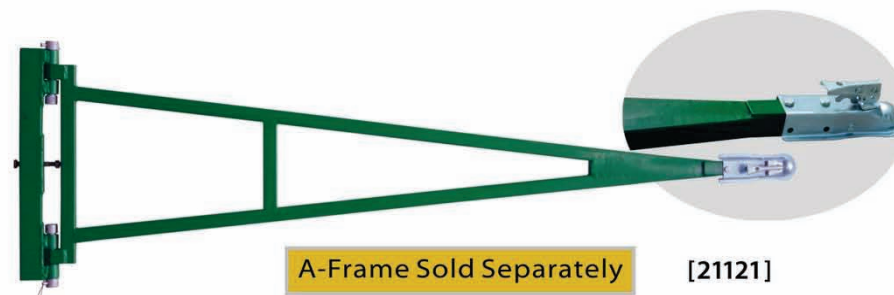

A-Frame Sold Separately

[21121]



[2111]



[2112]

RANGE PICKER I

Designed for lighter ball picking jobs and those hard to reach areas. Can be pushed or pulled.

- Picking width: 5'(152cm)
- Capacity: 1050 Balls

Order information:
2111 Range picker I

RANGE PICKER II

Designed specially for budget conscious range owners who want to utilize an electric cart for picking their range.

- Picking width: 7'(210cm)
- Capacity: 1400 Balls

Order information:
2112 Range picker II

A-FRAME

- Complete with one coupler and mounting bracket.
- A-Frame sold separately.

Order information:
21121 A-FRAME (78"long)



[2114]



[2115]

RANGE PICKER III

Manufactured specifically for rough, uneven ranges with steep sides and bare spots. Push Bar and mounting bracket included. Can be easily increased to a five gang ball picker.

- Picking Width: 9'(274cm)
- Ball Capacity: 2100 Balls

Order information:

2114 Range picker III

RANGE PICKER V

Designed for medium to heavy volume range operations. Push bar and mounting bracket included.

- Picking width: 15'(457cm)
- Ball capacity: 3500balls

Order information:

2115 Range picker V

MINI PICKERS

Use this hand-operated picker for those hard to reach areas or makeshift fairway ranges and practice areas.

Order information:

21161 Mini-PICKER I
Picking width: 18"(46cm);
Ball Capacity: 350pcs Balls

21162 Mini-PICKER II
Picking width: 23-½"(60cm);
Ball Capacity: 500 Balls

21163 Mini-PICKER III
Picking width: 36"(92cm);
Ball Capacity: 700 Balls



[21162]



[21161]



[21163]

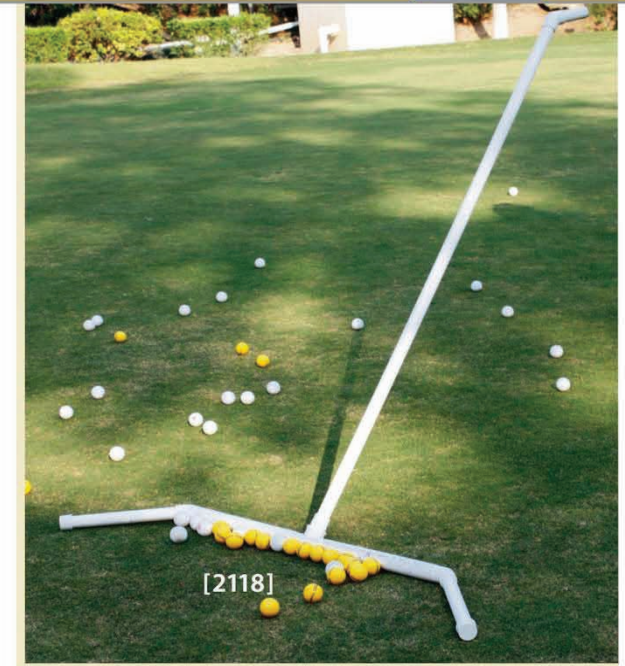

[2118]

BALL SWEEPER

This light weight tool is a fast and efficient aid to remove golf balls from your practice green during lesson time. Made from durable PVC tube and with a roller action.
Size: 3.5'X5'(106cm x 152cm)

Order information:

2118 Ball sweeper

REPLACEMENT BASKETS

Made from heavy guage steel wire, vinly-coated black finish.

Order information:

211731 Replacement basket
(Fit 2111,2112,2114, 2115,21161,21163)

211732 Replacement basket (Fit 21162 only)

REPLACEMENT DISC

Strong and flexible composite plastic discs, built to endure the toughest picking conditions.

Order information:

21171 Replacement disc



[211732]



[211731]



[21171]



[2121]

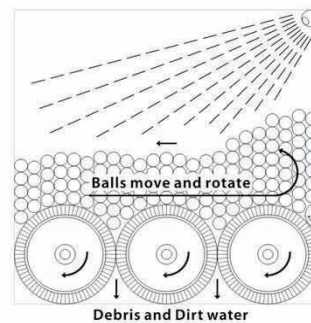

RANGE BALL WASHER

We are proud to introduce our new improved rang ball washer that is redesigned and innovated in many respects:

- All stainless steel and plastic construction will assure that there will be no rust or corrosion.
- The exclusive " Spiral Flute Brush" design delivers the most complete cleaning possible .
- Integrated ball gate demonstrate convenient and easy to use.
- Single-swinging open lid make the cleaning job more efficiency.
- Less friction ensure minimum damage to balls.

Power: 380V/50Hz ,750W,
 Net Weight: 160KG
 Size: 5-1/3'W X 2-1/10'D X 2-4/5'H
 (163cmWX64cmDX85cmH)

Order information:
2121 Range Ball Washer
2120 Brush Drum

BRUSH DRUM



[2120]



[2211]

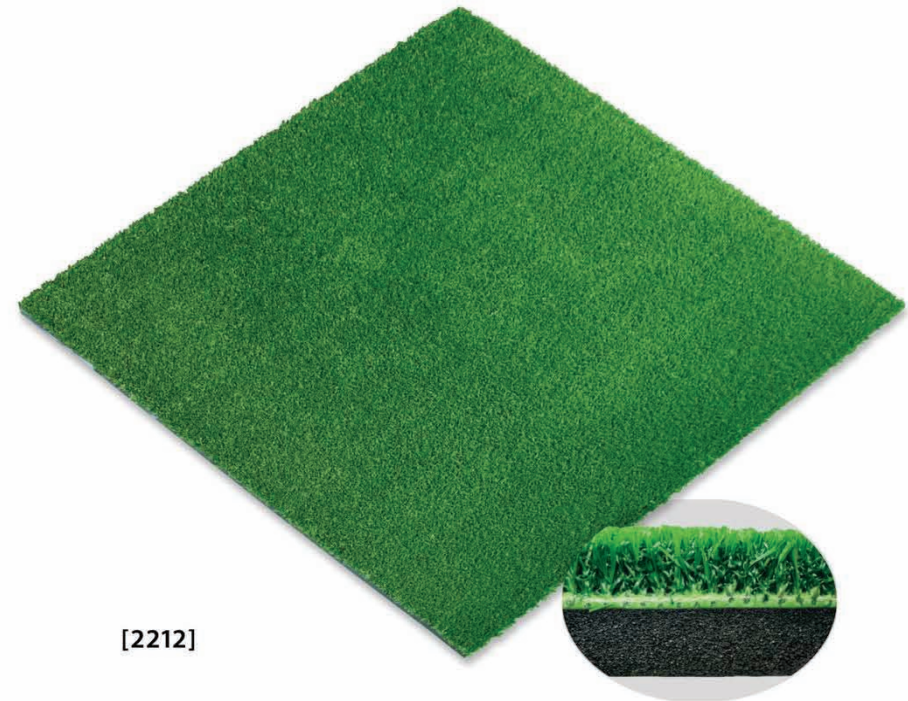

[2212]

SHOCK-SAVER MAT

These popular mats set the standard for quality and durability. They are constructed from high quality nylon turf and resilient foam padding. The foam padding can be standard 15mm or alternative 20mm thick, both soft enough to absorb impact and strong enough to avoid distortion.

Standard Size: 59"X59"X1-1/5" (150cmx150cmx30mm), (15mm foam)
 Alternative Size: 59"X59"X1-3/8" (150cmx150cmx35mm), (20mm foam)

Order information:

- 22111A** Shock-Saver Mat Standard -Square
- 22111B** Shock-Saver Mat Standard -Octagon
- 22112A** Shock-Saver Mat alternative -Square
- 22112B** Shock-Saver Mat alternative -Octagon

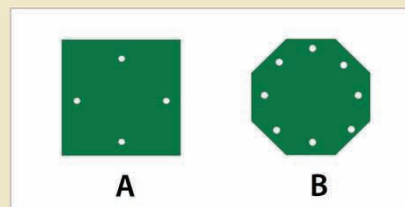

DUAL-GRASS MAT

The Dual-Grass Mat combines both straight and curled fibre. The straight fibre keeps the ball elevated for less clubhead resistance and the curled fibre provides cushioning and grip for player comfort and confidence. The foam padding can be standard 15mm or alternative 20mm thick.

Standard Size: 59"X59"X1-1/5" (150cmx150cmx30mm), (15mm foam)
 Alternative Size: 59"X59"X1-3/8" (150cmx150cmx35mm), (20mm foam)

Order information:

- 22121A** Dual-Grass Mat Standard-Square
- 22121B** Dual-Grass Mat Standard-Octagon
- 22122A** Dual-Grass Mat Alternative-Square
- 22122B** Dual-Grass Mat Alternative-octagon

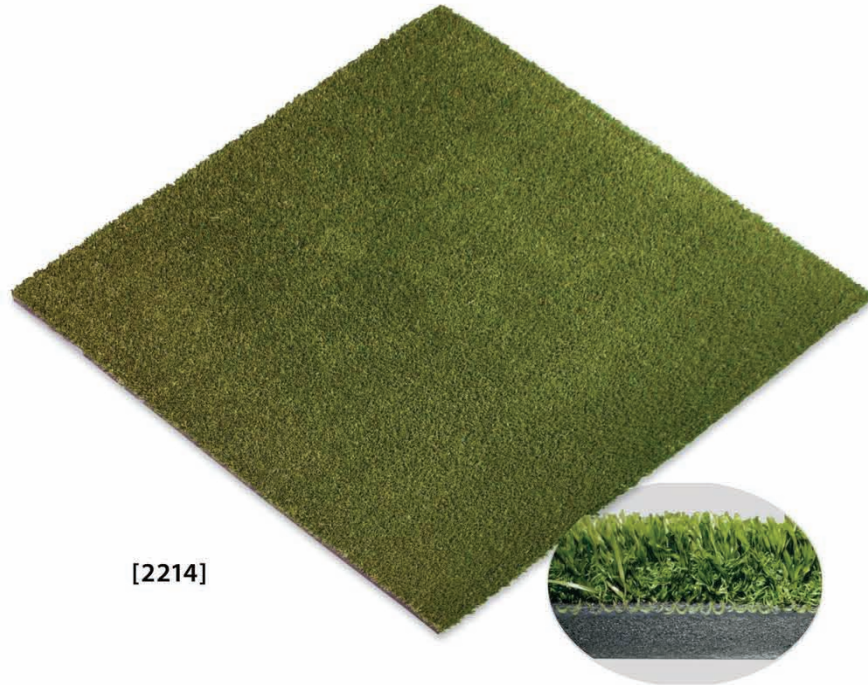

[2214]

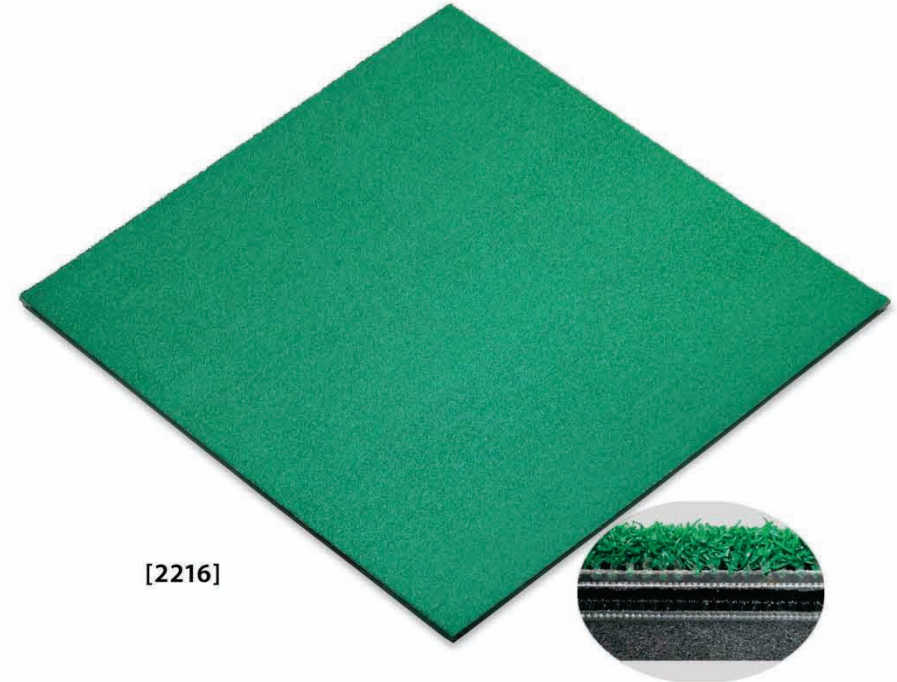

[2216]

DELUXE ROUGH AREA MAT

The Deluxe Rough Area Mat is designed to simulate play from heavier or longer grass by using a longer fibre. This provides an increased resistance at impact for both the ball and club head and encourages the player to connect with the ball first and accelerate the club head through the impact zone.

Order information:

- 2214A** DELUXE ROUGH AREA MAT-square
Size: 59"X59"X1-9/10" (150cmX150cmX48mm), (15mm foam)
- 2214B** DELUXE ROUGH AREA MAT-octagon
Size: 59"X59"X1-9/10" (150cmX150cmX48mm), (15mm foam)

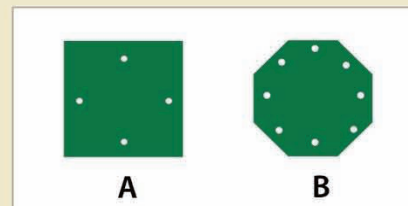

MULTI-FLEX MAT

Featuring shock absorbing layer of three dimensional air cushion. The spring-like layer creates an incredibly soft feel and providing extra protection to golfer's wrists.

Order information:

- 2216A** MULTI-FLEX MAT-square
Size: 59"X59"X1-3/8" (150cmX150cmX35mm)
- 2216B** MULTI-FLEX MAT-octagon
Size: 59"X59"X1-3/8" (150cmX150cmX35mm)



[2217]



[2200]

TEE-UP MAT

By constructing the Tee Up Mat with a curled thick fibre and foam padding, this unique design allows the player to use a normal wooden tee to replicate actual play and vary tee heights during a practice session. The player is encouraged to stay on the Mat for the whole practice session rather than seeking out and damaging a grassed area.

Order information:

2217 Tee- up mat Square 59"x59"x2"
59"x59"x2"(150cmX150cmX5cm)

TEACHING MAT

This teaching/practice mat come with whitestripe and center indicator which permanently imbedded in the mat, assist golfer to have the correct swing and stance. Constructed from high quality nylon turf and resilient foam padding.

Order information:

2200 Teaching Mat Square 59"x59"x1-3/8"
59"x59"x2"(150cmX150cmX3.5cm)

CLASSIC ANTI-SHOCK FRAME BASE SYSTEM

- The Classic Anti-shock frame base system has a combination of air and elasticity for improved shock absorption for comfortable play.
- 4- piece 100% PU Foam frame base is an independent unit compatible with many hitting mat inserts.
- All systems can be configured as single hitting mat or two hitting mats.

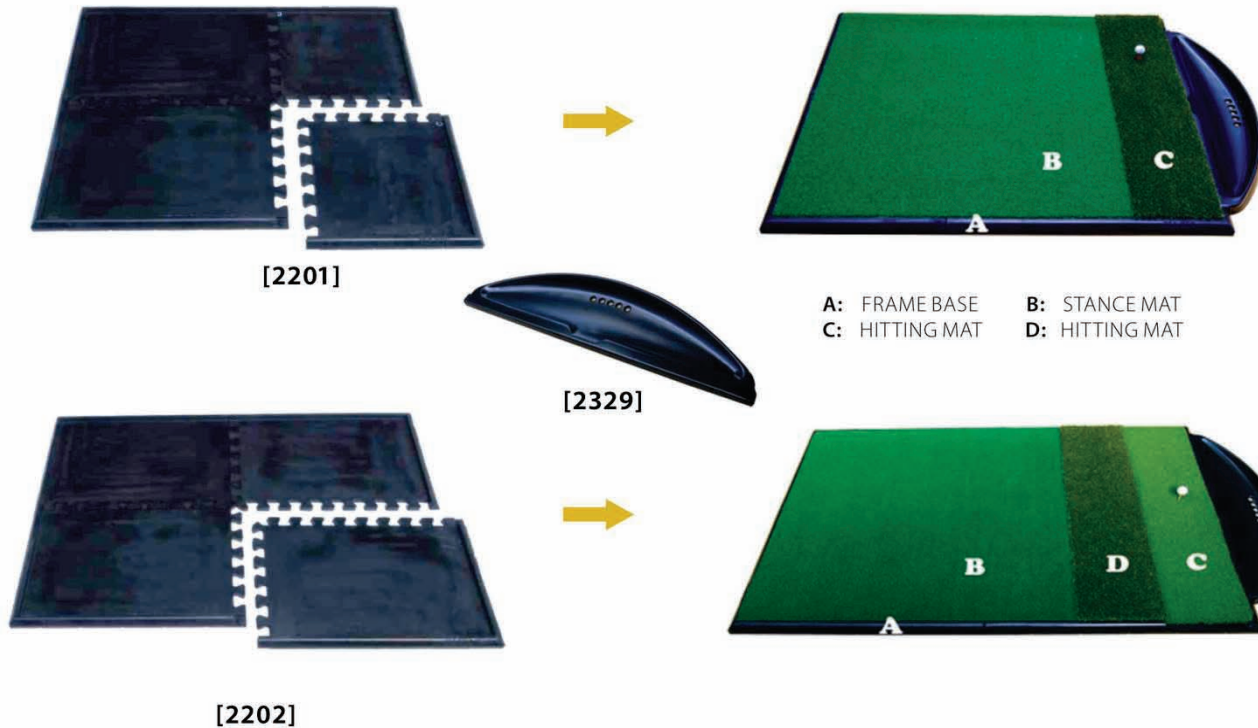

HITTING MATS (MAT INSERTS)



[2217H]



[2212H]



[2218H]



[2214H]

CLASSIC ANTI-SHOCK FRAME BASES

Order Information:

2201 With Single Hitting Mat.

Size: 50- 3/4" x 62- 5/8" x 1- 3/4"
129cm x 159cm x 45mm

2202 With Two Hitting Mats.

Size: 50- 3/4" x 74- 3/8" x 1- 3/4"
129cm x 189cm x 45mm

CURVED BALL TRAY

Designed for Anti-Shock Frame Base only. Holds up to 130 balls. 100% ABS material.

Size: 42- 1/8" x 11- 3/8" x 3- 3/8"
107cm x 29cm x 85mm

2329 Curved Ball Tray

STANCE MAT

Size: 47- 1/4" x 47- 1/4" x 1- 3/16"
120cm x 120cm x 30mm

2211S Stance Mat (Shock-Saver Mat)

HITTING MATS (MAT INSERTS)

Size: 47- 1/4" x 1- 3/16"
120cm x 30mm

2217H Tee-Up Mat Insert

2212H Dual Turf Mat Insert

2218H Heavy Duty Rough Insert

2214H Deluxe Rough Insert



[2370]



[2371]



[2233]



[2325]



[2231]



[2328]



PYRAMID STACKER

Simply place the Pyramid Filler over a Pyramid tray and pour ! In several seconds you have a perfectly formed pyramid. Each tray holds an exact count every time. The pyramid adds a quality appearance to any driving range.



PLASTIC PYRAMID TRAYS

Made from high impact plastic.
Order information:

- 23701** 55 Ball Plastic Tray
- 23702** 91 Ball Plastic Tray
- 23703** 140 Ball Plastic Tray
- 23704** 204 Ball Plastic Tray

PYRAMID STACKER

Constructed from stainless steel.
Order information:

- 23711** 55 Ball Pyramid Stacker
- 23712** 91 Ball Pyramid Stacker
- 23713** 140 Ball Pyramid Stacker
- 23714** 204 Ball Pyramid Stacker

RUBBER TEE HOLDERS

These rubber tee holders allow you to use your regular wooden tees in any mat rather than the rubber tees that are not adjustable and not realistic.

Order information:

- 22331** 1-1/2"(38mm)
- 22332** 1-3/4"(45mm)
- 22333** 2"(51mm)

RUBBER TEES

Made from high quality rubber which is both soft and durable.
Order information:

- 22311** 1-1/2"(38mm) Rubber Tee
- 22312** 1-3/4"(45mm) Rubber Tee
- 22313** 2"(51mm) Rubber Tee
- 22314** 2-1/4"(57mm) Rubber Tee
- 22315** 2-1/2"(64mm) Rubber Tee
- 22316** 2-3/4"(70mm) Rubber Tee
- 22317** 3"(76mm) Rubber Tee

PLASTIC BALL TRAY

Made of PE material, available in dark green.
Size: 24"Wx13-1/2"Dx4"H
(W61cmXD34cmXH10cm)
Weight: 1.4Kg

Order information:

- 2325** Plastic Ball Tray

RUBBER BALL TRAY

This ball tray can hold more than 100pcs golf balls. It's made of recycled crumb rubber and has a contoured edge to the mats allowing you to pull balls from the tray to the mat seamlessly. Absorbs noise of golf balls , won't move, won't crack. Weight: 9kg(19.8 lb)

Order information:

- 2328** Rubber Ball Tray

STANDARD RANGE BALL

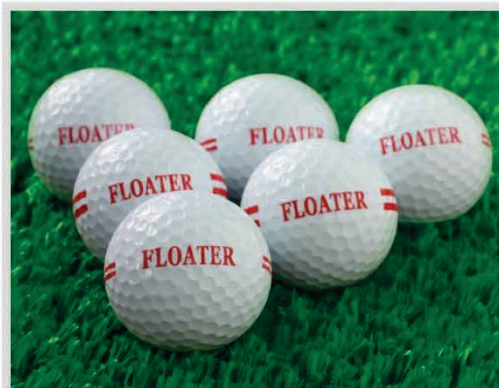

Customized LOGO is available upon request

1-PC STANDARD RANGE BALL

One piece construction using high-tech rubber; Maintains excellent appearance and playability after extensive use.

Order information:

22211A 1pc standard Range Ball-White

22211B 1pc standard Range Ball-Yellow

2-PC STANDARD RANGE BALL

Our high quality and performance of 2-pce range ball with its superior cut resistant cover provides you with longer durability and high performance.

Order information:

22221A 2pc standard Range Ball-White

22221B 2pc standard Range Ball-Yellow

FLOATER GOLF BALL

Floater Golf Ball is designed for driving ranges with ponds. It's molded with a low density solid center which allows it to float and features a water resistant and cut-resistant surlyn blend cover for maximum protection and long-term use.

Order information:

2224A Floater golf Ball-White

2224B Floater golf Ball-Yellow

CUSTOM GOLF BALL

Most suitable for promotion ,premium or gift use. Your logo can be imprinted on our tournament golf balls as well as titanium golf ball, Logo imprints are available up to six colours.

Order information:

2225 Custom golf ball



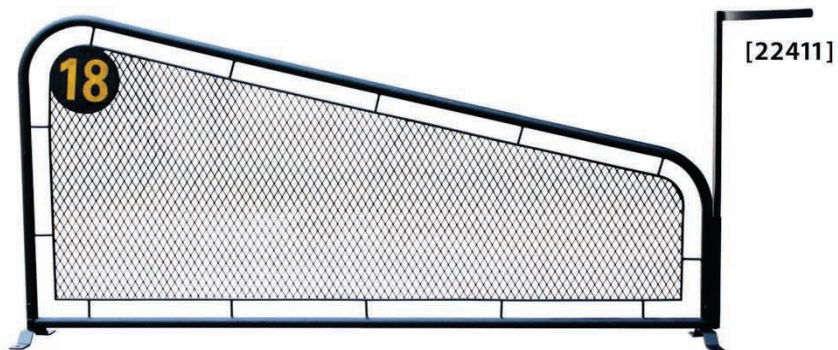

[2241]

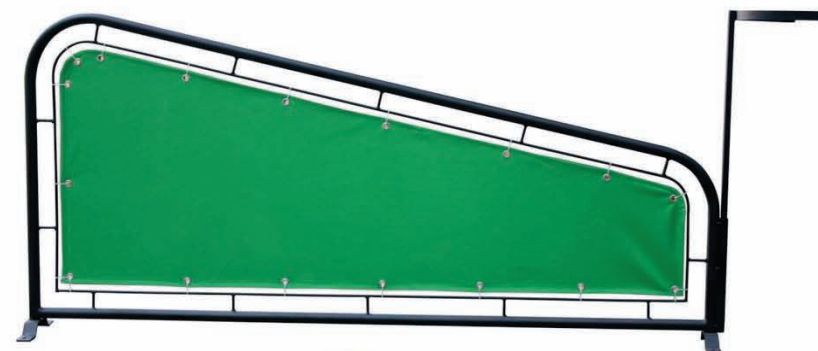

[2242]



[2243]



[2244]



[2245]

HEAVY DUTY TEE DIVIDERS

- Heavy duty steel pipe and bar construction frame, finished with powder coated to prevent rust.
- Steel mesh welded to the frame, formed with the body as one piece to withstand strong wind.
- Tee number can be imprinted or stuck with number decals.
- Canvas banner tightened to the frame with plastic snap. your logo/company name ,or tee number can be imprinted on them.
- Bag stand can be easily attached.
- Size: 60"X28-3/4"(152cm X 73 cm)

Order Information:

- 2241** Steel mesh tee divider **22411** Optional bag stand
2242 Canvas tee divider

STAINLESS STEEL TEE DIVIDERS

- Stainless steel tubing construction frame tightened with canvas cloth, your logo/company name can be imprinted on cloth or round steel plate.
- Strong plastic mirror shows player address and impact position. Two different constructions for your choice.

Order information:

- 2243** Stainless steel tee divider
 Size: 60"X26"(152 X 66 cm) **2245** Stainless steel tee divider with mirror
 Size: 60"X20"(152 X 51cm)
2244 Stainless steel tee divider with mirror
 Size: 60"X27"(152 X 69cm)

HEAVY DUTY PLASTIC DIVIDER

- This heavy duty divider is totally made from durable recycled plastic, built to last and designed to enhance the beauty of your driving range.
- The top of the divider is designed as a garden container to be filled with soil, so the part of plant or flowers can grow there to enhance the beauty of your tee line.
- Can be customized with customer logo, rang map and tee number. A information box may be attached upon your request.
- Please specify color or color combination when ordering, see page 25 for details.
- Size: 59" W x 10" D x 27" H (150cm W x 25cm D x 69cm H)

Order information:

2260 Heavy Duty Plastic Divider



[2260]



RANGE MAP

INFORMATION BOX

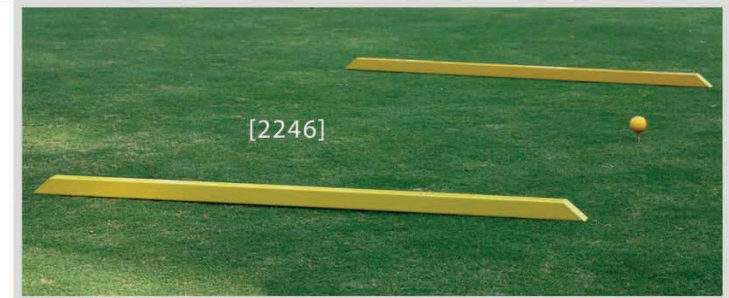

[2246]

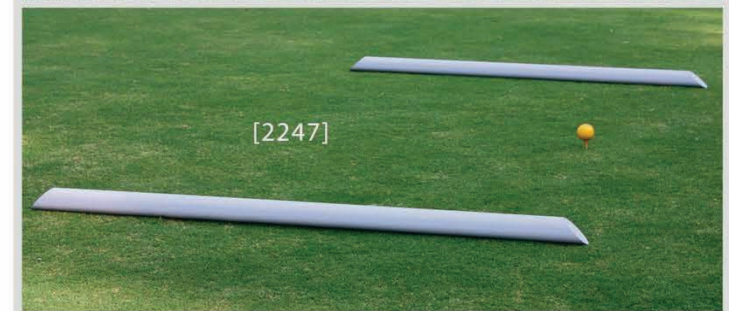

[2247]

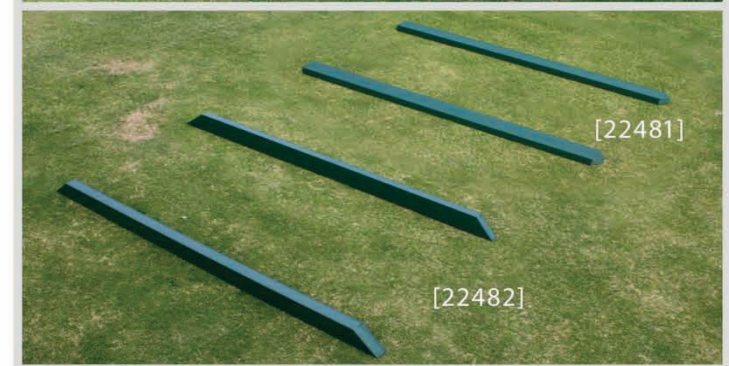

[22481]

[22482]

RECYCLED PLASTIC DIVIDER

- Durable recycled plastic dividers in three distinct styles
- Three spikes on the under side to hold in position.
- 48" (120cm) width

Order information:

	1.5"(3.8cm)square	2"(5.0cm)round	3.5cm×7cm
Red	2246A	2247A	
Yellow	2246B	2247B	
Green	2246C	2247C	22481; 22482
White	2246D	2247D	

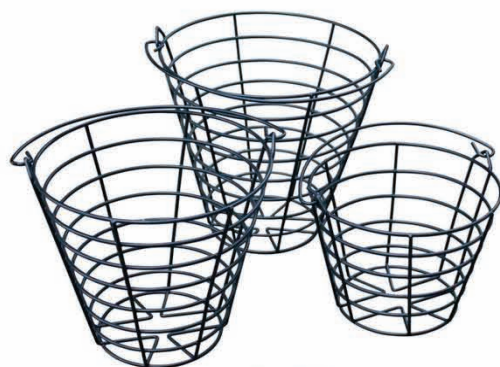

[2321]



[2322]

STEEL BALL BASKETS

Made from heavy gauge steel wire, vinyl-coated black. Available in different size. Color: Black

Item NO.	Bottom(cm)	Top(cm)	Height(cm)	Capacity(balls)
23213	14	21	16	50-55
23216	14	26	25	100-110

PLASTIC BALL BASKETS

High quality material provides better durability. Two sizes available for your choice. Color: Green

Item NO.		Bottom(cm)	Top(cm)	Height(cm)	Capacity(balls)
23222	Medium	12.7	22.6	21.5	70-75
23223	Large	14.2	25.4	24.7	100-110



[2323]



[2331]



[2332]

RANGE BALL STACKING BOX

Made of durable plastic, This box can be stacked up in layers to create a clean and organized tee line while increasing labor efficiency. Ball capability: 30pcs balls

Order information: **2323A** Yellow **2323B** Dark green

MESH RANGE BAGS

Strong Polyester mesh, single drawstring with cord lock.

CODE	SIZE	BALL CAPACITY
23311		20-30
23312		40-45
23313		60-65
23314		90-95

CANVAS RANGE BAGS

Cotton twill double core drawings and brass grommets.

CODE	SIZE	BALL CAPACITY
23321		20-30
23322		40-45
23323		60-65
23324		90-95



[23111]



[23112]



[2313]



[23113]

STEEL BAG RACKS

A heavy duty, stable bag rack made from steel tubing with powder coated. This rack has a steel mesh plate at the bottom to protect golf bags. It can be easily disassembled for transportation. Color: Black/White.

Order information:

23111 Steel 1-Bag Stand
Size: 15"X20-1/2"X29-1/2"
(W38cmXD52cmXH75cm)

23112 Steel 6-Bag Rack
Single Sided
Size: 78"X20-1/2"X29-1/2"
(W198cmXD52cmXH75cm)

23113 Steel 12- Bag Rack
Double Sided
Size: 78"X43"X32"
(W198cmXD109cmXH81cm)

ECONOMY BAG STAND

A stable bag rack made from steel tubing with powder coated.
Size: 15-3/4"X23"X25-3/5";
(W40cmXD59cmXH65cm)

Order information:

2313 Economy Bag Stand



[2300]



[23142]



[2315]



[2310]



[23141]

BAG RACKS AND BAG STANDS

- Constructed from maintenance free recycled plastic lumber.
- Foldable for easy storage.
- Please specify color when ordering.

Color Options



Bag Stand Options:



Bag Stand Options available on select Bag Stand at an extra cost:

- 231AT** AmenityTray \$3
- 231CH** CupHolder \$10
- 231CG** Club Grooves \$3

Order information: **23141** R-Frame Bag Stand-Lw
2300 Deluxe Bag Stand **2315** A-Frame Bag Stand
23142 R-Frame Bag Stand-HD **2310** Bag Stand



[23171]



[2305]



[23172]



[4100]

BAG RACKS

- Constructed from recycled plastic.
- Please specify color or color combination when ordering, please refer to page 26 for details.

Order information:

2305 Deluxe 5- Bag Rack
Size: 81"W * 16"D * 33"H
(206cmW * 41cmD * 84cmH)

4100 Deluxe 5- Bag Rack
Size: 70"W * 18"D * 38"H
(178cmW * 46cmD * 97cmH)

23171 Deluxe 3- Bag Rack
Size: 44"W * 18"D * 32-2/3"H
(112cmW * 46cmD * 83cmH)

23172 Deluxe 5- Bag Rack
Size: 70"W * 18"D * 32-2/3"H
(178cmW * 46cmD * 83cmH)

5 BAG RACKS

- Constructed from recycled plastic.
- Single-sided, total 5 bag capacity.
- Additional racks can be placed side-by-side or back-to-back for added capacity.
- Dimension: 74"Wx23"Dx30"
(180cmW x58.5cmDx76cmH)

Order information:

23161 5 Bag Rack

DOUBLE-SIDED BAG RACK

- Constructed from recycled plastic.
- Double-sided, total 10 bag capacity.
- Dimension: 74"Wx44.5"Dx30"
(180cmW x113cmDx76cmH)

Order information:

23162 Double-Sided Bag Rack

Color Options



PORTABLE BAG RACK

- Constructed from recycled plastic with 3-1/2" (9cm) square posts.
- Available in either 5 bag capacity (single sided) or 10 bag capacity (Double sided)
- Dimension: 71"W x 30"H (180cm x 76cm)

Order information:

Portable Bag Rack

32181 5 Bag Capacity-Single Sided

32182 10 Bag Capacity-Double Sided

PERMANENT MOUNT BAG RACK

- Constructed from recycled plastic with 3-1/2" (9cm) square posts.
- Available in either 5 bag capacity (single sided) or 10 bag capacity (Double sided)
- Dimension: 71"W x 42"H (180cm x 110cm)

Order information:

Permanent Mount Bag Rack

32191 5 Bag Capacity-Single Sided

32192 10 Bag Capacity-Double Sided



[23161]



[23162]



[32182]



[32191]

RANGE BANNERS

New banner material: The new "Textilene fabric" mesh material makes the banner most durable, high strength and excellent weather resistance.

New Metal Frame: Complete aluminium tubing and fittings are rust-free and strong enough to withstand high impact from the ball.

Size: 48"X24"(122cmX61cm) Horizontal
24"X48"(61cmX122cm) Vertical

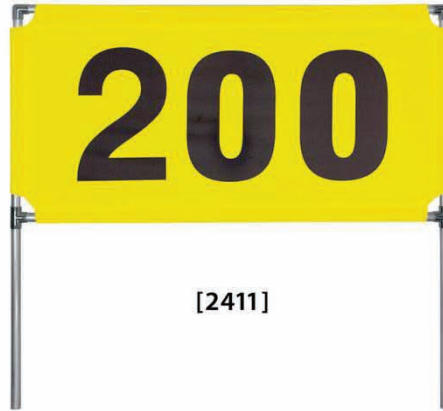

[2411]

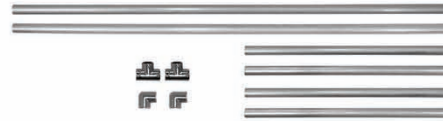

[24117]

Order information:

- 24111 Range banners Horizontal 50
- 24112 Range banners Horizontal 100
- 24113 Range banners Horizontal 150
- 24114 Range banners Horizontal 200
- 24115 Range banners Horizontal 250

- 24121 Range banners Vertical 50
- 24122 Range banners Vertical 100
- 24123 Range banners Vertical 150
- 24124 Range banners Vertical 200
- 24125 Range banners Vertical 250

- 24117 Range banner frame kit



[2413]



[2415]



[2414]

RANGE MARKERS

- Constructed from two-tone HDPE laminated plastic specially designed to withstand the harshest outdoor conditions.
- Engraved white numbers on green
- Pre-drilled holes for post mount (post not included)

Horizontal Rang Markers

Size: 31"WX24"H (78cmX61cm)

Order information:

- 24131 Horizontal Range marker 50
- 24132 Horizontal Range marker 100
- 24133 Horizontal Range marker 150
- 24134 Horizontal Range marker 200
- 24135 Horizontal Range marker 250

Vertical Rang Markers

Size: 12"WX48"H(30cmX122cm)

Order information:

- 24141 Vertical Range marker 50
- 24142 Vertical Range marker 100
- 24143 Vertical Range marker 150
- 24144 Vertical Range marker 200
- 24145 Vertical Range marker 250

Oval Rang Markers

Size: 48"WX30"H(122cmX76cm)

Order information:

- 24151 Oval Range marker 50
- 24152 Oval Range marker 100
- 24153 Oval Range marker 150
- 24154 Oval Range marker 200
- 24155 Oval Range marker 250



[24183]



[2418-00]



Individual Number:

RANGE SIGNS

Order information:
Come completely with frame:

- 24181 Range Sign 50
- 24182 Range Sign 100
- 24183 Range Sign 150
- 24184 Range Sign 200
- 24185 Range Sign 250

Individual Number:

- 2418-01 Number "0"
- 2418-02 Number "1"
- 2418-03 Number "2"
- 2418-04 Number "5"
- 2418-00 Mounting sleeve

RANGE SIGNS

- Highly visible, easy to move for ball collection and mowing.
- Signs are made of high quality nylon turf, one-piece construction.
- Post and bracing bracket are made of recycled plastic, pre-assembled with in-ground mounting sleeve.
- Size: 48"WX48"(12cmX120cm)



CHIPPING NETS

24511 Adjustable Chipping Net

Powder coated steel frame with PE netting sewn into the frame
 Dia.17"XH17"-3/4"
 (43cmXH45cm)



[24512]

24512 Chipping Net

Stainless steel frame with PE netting sewn into the frame
 Dia.22-4/5"XH18"



[24521]

24513 Chipping Net

Powder coated steel frame with PE netting sewn into the frame
 Dia.50"XH30"
 (127cmXH76cm)



[24511]



[24513]

TARGET NETS

Powder coated steel frame with PE netting sewn to the frame. These target nets are easily assembled and can be used either as chipping nets or placed on the range as target nets.

Order information:

24521 Target net 1m Dia.

24522 Target net 2m Dia.

24523 Target net 3m Dia.



[24522]



[24523]

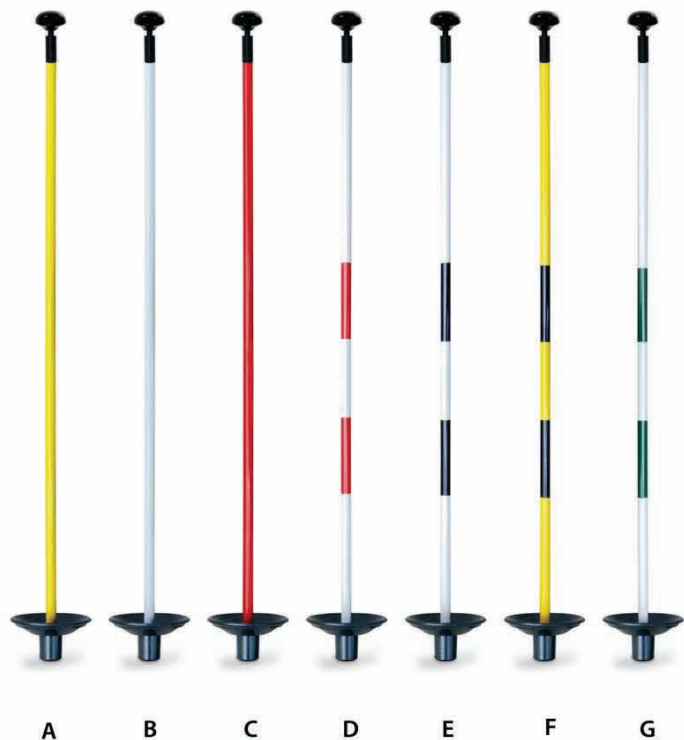

[2432]

PRACTICE GREEN FLAGSTICKS

Fiberglass rod and plastic ferrule. Come with a ball nut Dia.41mm
 Size: 34-4/5"(86cm) tall, 1/2"(12.7mm) diameter rod

Order information:

- | | |
|---------------------------|---------------------------|
| 2432A Solid Yellow | 2432E White/black |
| 2432B Solid White | 2432F Yellow/black |
| 2432C Solid Red | 2432G White/green |
| 2432D White/red | |



[2441]



[2442]



[2443]



[2444]

PRACTICE GREEN FLAGS

High quality nylon material, Size: 9"X6"(23cmX15cm)

PRACTICE GREEN SOLID FLAGS

- | | |
|---------------------------|--------------------------|
| 2441A Solid Red | 2441D Solid White |
| 2441B Solid Yellow | 2441E Solid Gold |
| 2441C Solid Blue | 2441F Solid Green |

PRACTICE GREEN NUMBER FLAGS

- | | |
|--------------------------|----------------------------|
| 24431A Red 1-9 | 24432A Red 10-18 |
| 24431B Yellow 1-9 | 24432B Yellow 10-18 |
| 24431C Blue 1-9 | 24432C Blue 10-18 |
| 24431D White 1-9 | 24432D White 10-18 |
| 24431E Gold 1-9 | 24432E Gold 10-18 |

PRACTICE GREEN CHECKERED FLAGS

- | | |
|---------------------------|--------------------------|
| 2442A Yellow/black | 2442D White/black |
| 2442B White/ green | 2442E Gold/black |
| 2442C White/red | 2442F White/Blue |

CUSTOM PRACTICE GREEN FLAGS

High quality nylon material. Your custom logo can be screen printed or embroidered on the flags.

- | |
|------------------------------------|
| 24441 Custom screen printed |
| 24442 Custom embroidered |

PLASTIC CUPS

Durable bright white plastic featuring minimum taper.

Order information:

2421 4"(10.2cm) practice cup

3333 6"(15.2cm) Putting cup

DELUXE PRACTICE GREEN FLAGSTICKS

Deluxe Practice Green Flagsticks feature an extra thick fiberglass tube in the center section, for greater strength, visibility and wind resistance.

Order information:

2433A Solid White

2433B Solid Yellow

2433C White/red

2433D White/black

2433E White/green

2433F Yellow/black

PRACTICE GREEN MARKERS

Fiberglass rod, plastic head and ferrule. Each head includes number decals on both sides. Please specify hole number when ordering. Available in red/white and green/white colors. The marker can be personalized with decals feature club logo.

Also available without number.
36-3/5"(93cm) tall,
8/25"(0.8cm) diameter rod.

Order information:

24311A Red/white (without number)

24311B Green/white (without number)

24312A Red/white (number 1-9)

24312B Green/white (number 1-9)

24312C Red/white (numbers 10-18)

24312D Green/white (numbers 10-18)

243120 Personalized markers.



[2421]



[3333]



[2431]

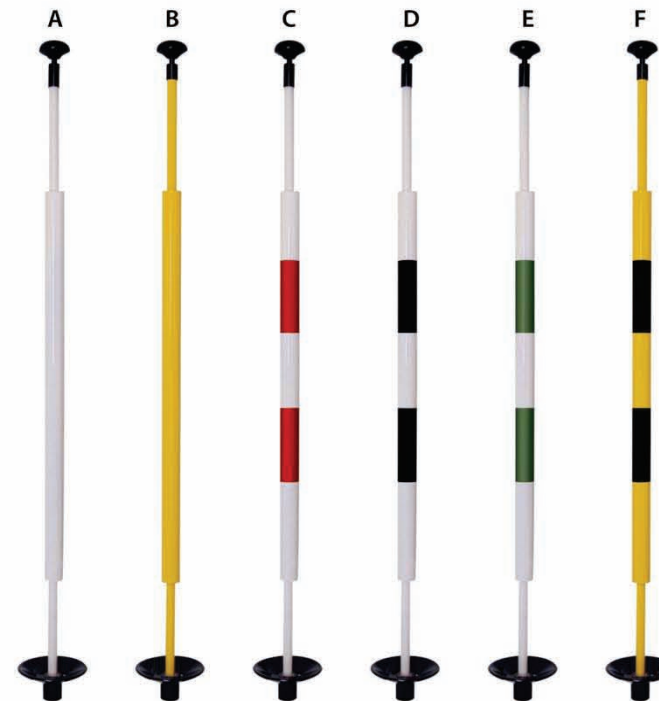

[2433]



[3619]

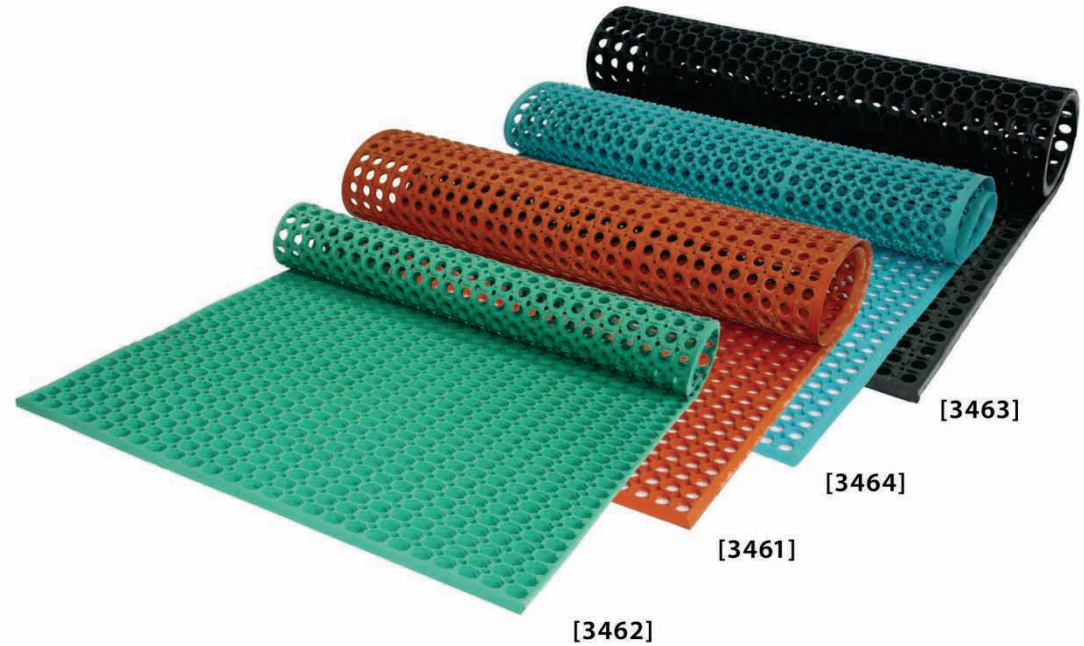

[3463]

[3464]

[3461]

[3462]

SHAG BAG

Made from aluminium alloy that will not rust and a strong canvas bag that will not stretch, making collecting your golf balls a breeze.

Whole length: 32" (81cm) N. Weight: 1-1/2 lb(0.68kg)

Max capacity: 100pcs standard golf balls

Order information:

- 3619A** Red
- 3619B** Yellow
- 3619C** Green
- 3619D** Black

RUBBER MATS

These mats are made from recycled rubber and have a number of uses. They can be used in the club house as safety mats, stair tread mats and even to protect particular grassed areas against erosion. They are available in black, brown and green and come in 4 sizes.

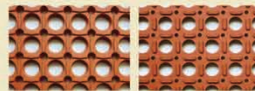

Front Mat I Back

Mat I 60"X36"X3/5"

- 3461A** Rubber mat I-Black
- 3461B** Rubber mat I-Blue
- 3461C** Rubber mat I-Green
- 3461D** Rubber mat I-

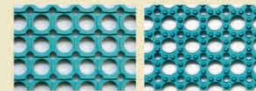

Front Mat II Back

Mat II 58"X39"X7/8"

- 3462A** Rubber mat II-Black
- 3462B** Rubber mat II-Blue
- 3462C** Rubber mat II-Green
- 3462D** Rubber mat II-Brown



Front Mat III Back

Mat III 40"X32"X1/2"

- 3463A** Rubber mat III-Black
- 3463B** Rubber mat III-Blue
- 3463C** Rubber mat III-Green
- 3463D** Rubber mat III-Bro

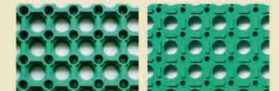

Front Mat IV Back

Mat IV 60"X36"X1/2"

- 3464A** Rubber mat IV-Black
- 3464B** Rubber mat IV-Blue
- 3464C** Rubber mat IV-Green
- 3464D** Rubber mat IV-Brown

COMPRESSED WATER VAPOR CLEANER

- Completely made of stainless steel.
- Utilizes compressed air to nebulize water into water vapor.
- Blow dirt and grass off shoes with water vapor.
- Features a easy- removable tray to dump the dirt for a simple.
- Included air wands but compressor not included.
- Size: 94"Lx20-2/3"Wx40"H
(240cmx53cmx102cm)

Order information:

3472 Compressed Water Vapor Cleaner

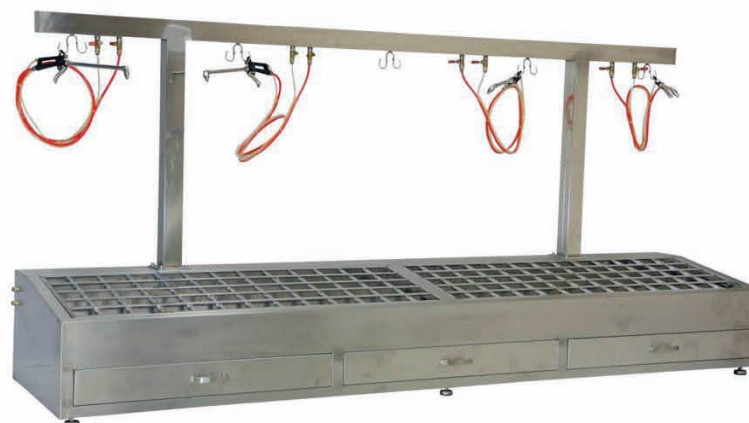

[3472]

JET CLEANER

This Jet Cleaner is completely made of stainless steel, utilizes compressed air to blow dirt and grass off the bottom of the golfers' shoes. Features a easy-removable tray to dump the dirt for a simple. Included air wands but compressor not included.

Order information:

34711 Jet Cleaner Pro
Size: 94"Lx20-2/3"Wx40"H
(240cmx53cmx102cm)

34712 Jet Cleaner Jr.
Size: 46"Lx19-1/2"Wx38"H
(116cmx50cmx97cm)



[34711]



[34712]

DUAL-COLOR SELECTION

Parsett golf is proud to introduce our new Dual-color products line: A full selection of products made from 100% recycled plastic in two tone color, built to last and designed to enhance the beauty of your course.



Available Panel colors

			
Green	Black	Beige	Brown

AVAILABLE PANEL & TRIM COLORS

You can choose your color combinations to create your own coordinated style

Available Trim colors

			
Green	Black	Beige	Brown

SPIKE AIR CLEANERS
BUILT TO LAST, AND DESIGNED TO ENHANCE THE BEAUTY OF YOUR COURSE!

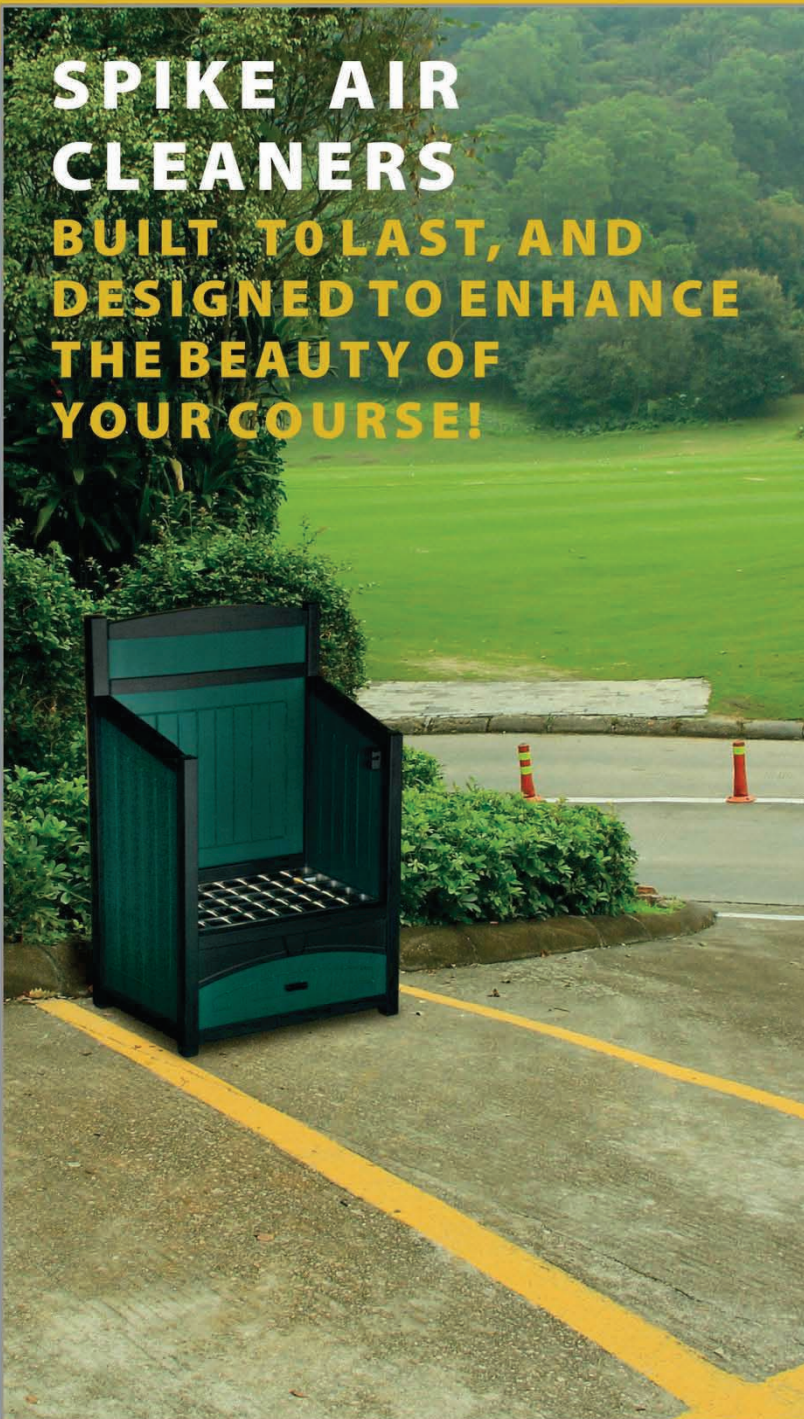

KING SPIKE AIR CLEANER

- Completely made of recycled plastic.
- Two-tone color construction, you can choose your own color combinations, please refer to page 25 for details.
- Utilizes compressed air to blow dirt and grass off shoes.
- Features a easy- removable tray to dump the dirts for a simple.
- Included air wands but compressor not included.
- Size: 26"Wx17-1/2"Wx43"H (66cmx45cmx110cm)

Order information:
4210 King Spike Air Cleaner



[4210]



[4220]

MASTER SPIKE AIR CLEANER

- Completely made of recycled plastic.
- Two-tone color construction, you can choose your own color combinations, please refer to page 25 for detail.
- Utilizes compressed air to blow dirt and grass off shoes.
- Features a easy- removable tray to dump the dirts for a simple.
- Included air wands but compressor not included.
- Size: 45"Wx17-1/2"Wx43"H (114cmx45cmx110cm)

Order information:
4220 Master Spike Air Cleaner



[4310]



[31531]



[31532]

- Constructed with recycled plastic. Rustproof, fade resistant and maintenance free.
- Please specify color when ordering.

Color Options



CLUB WASHER

- Includes a 5 gallon (20liter) pail, hand brush, hooks for hanging tee towels.
- Angled support for bracing club while scrubbing.

Order information:
31531 Club Washer

ROUND CLUB WASHER

- This club washer come with club washing liner and brushes. .
- Ideal for range and Par 3s
- Size: 16" Dia.x21"H (40cmDia.X53cmH)

Order information:
31532 Round Club Washer

SQUARE CLUB WASHER

- This club washer come with club washing liner and brushes
- Two-tone color construction. you can choose your own color combination, please refer to page 25 for details..
- Size:17"Wx17"Dx20"H (43cmX43cmX51cm)

Order information:
4310 Square Club Washer

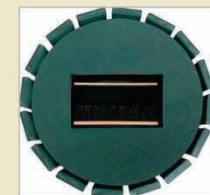

Constructed with recycled plastic.
Rustproof, fade resistant and
maintenance free
Assembly required
Please specify color when ordering.

Color option



CLUB RACK

Tiered rack holds 66 clubs.
Order information:
34111 Club Rack



[34111]

DEMO CLUB RACK

- The same construction as 66-club Rack.
- Added surfaces can be customized with your brand name, logo or other message.
- A great rack for any club vender or pro shop to display clubs during Demo event.

Order information:
34121 Demo Club Rack



[34121]

UMBRELLA RACK

Tiered rack holds 40 umbrellas.
Order information:
34131 Umbrella Rack



[34131]

CLUB HOLDER

This Club Holder can display 18 clubs.
Please specify color when ordering.
Order information:
3415 Club Holder



[3415]



[23462]



[2344]



[2343]

BENCHES

- Both seat slats and legs are made of recycled plastic.
- Tough, maintenance free and durable.
- Black plastic bolt covers included.
- Assembly required.

Slat Color Option



Engraved Slats Option

Your course's name, logo, or custom message can be added to your benches for a personalized look.

CONTOURED BACKLESS BENCH

Order information:

23462 5FT(152cm) Bench

NEW

BACKLESS BENCH

Order information:

23441 4FT(122cm) Bench-2 Legs

23442 5FT(152cm) Bench-3 Legs

23443 6FT(183cm) Bench-3 Legs

HIGH BACK BENCH

Order information:

23431 4FT(122cm) Bench-2 Legs

23432 5FT(152cm) Bench-3 Legs

23433 6FT(183cm) Bench-3 Legs



RECYCLED COURSE SIGNS

- 12"x 5-1/2" (30cm x14cm) signs made from recycled plastic with two stainless steel spikes.
- Message can be engraved either single side or double sides.
- Stocking color: White, Yellow, Green and Brown. Please specify color when ordering.

Order information

36141- ___ Single Sided

36142- ___ Double Sided

Please specify message, see below:

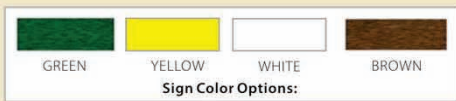

- | | |
|-----------------------------------|-------------------------------|
| -01 Ground Under Repair | -10 Wet Area Carts Keep Off |
| -02 Drop Area | -11 No Carts |
| -03 Next Tee (with one way arrow) | -12 Keep Carts 30' From Green |
| -04 Please Repair Ball Marks | -13 No Chipping |
| -05 Please Replace Divots | -14 Please Observe 90° Rule |
| -06 Please Rake Bunkers | -15 Putting Green Closed |
| -07 Please Keep Off | -16 Driving Range Closed |
| -08 Carts (with one way arrow) | -17 Chemicals Applied Today |
| -09 Keep Carts On Path | -18 Customized Signs |



[3614]



[3670]



[3671]



ENGRAVED LAMINATED PLASTIC SIGNS

If you are looking for low maintenance signs this is the answer. Using laminated layers of different colored plastic, the message or logo is engraved through the upper surface to expose the next color. These signs can be made in large sizes and will withstand beatings by golf clubs, balls and many of the typical vandal problems regularly encountered. Tough, long-lasting and outstanding fade-resistance.



LAMINATED PLASTIC FAIRWAY SIGNS

- single- or double-sided signage with 5" (13cm) stainless steel screw-in spikes.
- Choice of two sizes: 9"H x 15"W (23cm x 38 cm) or 6"H x 12"W (15cm x 30 cm).

Order Information:

GREEN/WHITE Laminated Plastic Fairway Signs-Large

Sizes: 9"H x 15"W (23cm x 38 cm)

36701- ____ Single Sided**36702-** ____ Double Sided

Please specify message, see below

GREEN/WHITE Laminated Plastic Fairway Signs-Small

Sizes: 6"H x 12"W (15cm x 30 cm)

36711- ____ Single Sided**36712-** ____ Double Sided

Please specify message, see below

-01 Ground Under Repair	-10 Wet Area Carts Keep Off
-02 Drop Area	-11 No Carts
-03 Next Tee (with one way arrow)	-12 Keep Carts 30' From Green
-04 Please Repair Ball Marks	-13 No Chipping
-05 Please Replace Divots	-14 Please Observe 90° Rule
-06 Please Rake Bunkers	-15 Putting Green Closed
-07 Please Keep Off	-16 Driving Range Closed
-08 Carts (with one way arrow)	-17 Chemicals Applied Today
-09 Keep Carts On Path	-18 Customized Signs



ARROW DIRECTION SIGNS

- One-piece construction recycled plastic signs.
- Engraved message and poured on both sides.
- 13.75in. (35cm) long
- Custom sizes are available upon request.

Sign Color Options

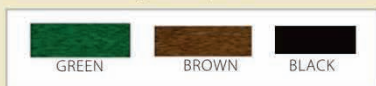

Order information:

3615 - ____ Double Sided

Please specify messages, see below:

-01 No. 1 Tee -06 No. 6 Tee -11 No. 11 Tee -16 No. 16 Tee
 -02 No. 2 Tee -07 No. 7 Tee -12 No. 12 Tee -17 No. 17 Tee
 -03 No. 3 Tee -08 No. 8 Tee -13 No. 13 Tee -18 No. 18 Tee
 -04 No. 4 Tee -09 No. 9 Tee -14 No. 14 Tee -19 Next Tee
 -05 No. 5 Tee -10 No. 10 Tee -15 No. 15 Tee -20 Carts

GREEN/BEIGE ARROW DIRECTION SIGNS

- Made from tough, long-lasting, solid laminated plastic, one-piece construction.
- Engraved message on both sides.
- 13.75" (35cm) long.
- Custom sizes are available upon request.

Order information:

3615L - ____ Double Sided

(Please specify messages, see below)



-01 No. 1 Tee -06 No. 6 Tee -11 No. 11 Tee -16 No. 16 Tee
 -02 No. 2 Tee -07 No. 7 Tee -12 No. 12 Tee -17 No. 17 Tee
 -03 No. 3 Tee -08 No. 8 Tee -13 No. 13 Tee -18 No. 18 Tee
 -04 No. 4 Tee -09 No. 9 Tee -14 No. 14 Tee -19 Next Tee

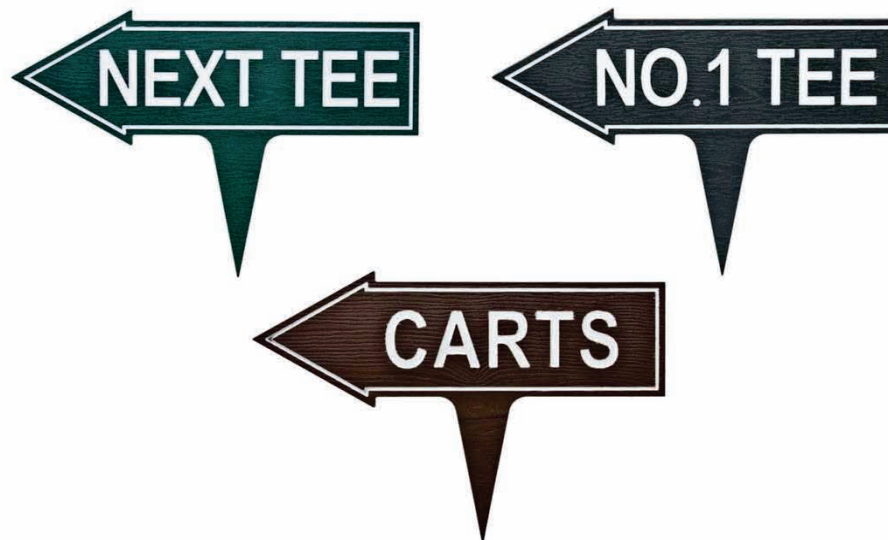

[3615]



[3615L]



[3616]



[3616L]

RECYCLED PLASTIC FAIRWAY SIGNS

- Made from recycled plastic, one-piece construction.
- Size : 6 H x 11 W (15cm X 28cm, not including spike).
- Engraved message on either single side or both sides.
- Customized signs are available upon request.

Sign Color Options

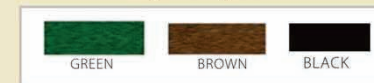

Order information:

36161 - ____ Single Sided

36162 - ____ Double Sided

Please specify messages, see below:

-01 Ground Under Repair	-10 Wet Area Carts Keep Off
-02 Drop Area	-11 No Carts
-03 Next Tee (with one way arrow)	-12 Keep Carts 30' From Green
-04 Please Repair Ball Marks	-13 No Chipping
-05 Please Replace Divots	-14 Please Observe 90° Rule
-06 Please Rake Bunkers	-15 Putting Green Closed
-07 Please Keep Off	-16 Driving Range Closed
-08 Carts (with one way arrow)	-17 Chemicals Applied Today
-09 Keep Carts On Path	-18 Customized Signs

GREEN/BEIGE PLASTIC FAIRWAY SIGNS

- Made from tough, long-lasting, solid laminate plastic, one-piece construction.
- Engraved message on either single side or both sides.
- Size: 6 H x 11 W (15cm X 28cm, not including spike)
- No painting needed, fad resistant.
- custom size available upon request.



Order information:

3616L1- ____ Single Sided

3616L2- ____ Double Sided

(Please specify messages, see below)

-01 Ground Under Repair	-10 Wet Area Carts Keep Off
-02 Drop Area	-11 No Carts
-03 Next Tee (with one way arrow)	-12 Keep Carts 30' From Green
-04 Please Repair Ball Marks	-13 No Chipping
-05 Please Replace Divots	-14 Please Observe 90° Rule
-06 Please Rake Bunkers	-15 Putting Green Closed
-07 Please Keep Off	-16 Driving Range Closed
-08 Carts (with one way arrow)	-17 Chemicals Applied Today
-09 Keep Carts On Path	-18 Customized Signs



**GREEN/BEIGE
ENGRAVED LAMINATED PLASTIC SIGNS**

- These signs are made from tough, long-lasting, solid two tone laminated plastic, one-piece construction.
- No painting needed and fade resistance.
- All signs can be engraved on either single side or double sides.
- Custom sizes are available upon request.



Single-spike Laminated Plastic Signs

Size: 9"WX6.75"H (23cmX17cm, not including spike)
Color: Beige on Green

Order Information:

36171S- ____ (Single Sided)

36171D- ____ (Double Sided)

Please specify messages (see below)

Twin-spike Laminated Plastic Signs

Size: 12.6"WX8"H (32cmX20cm, not including spike)
Color: Beige on Green

Order Information:

36172S- ____ (Single Sided)

36172D- ____ (Double Sided)

Please specify messages (see below)

- | | |
|-----------------------------------|-------------------------------|
| -01 Ground Under Repair | -10 Wet Area Carts Keep Off |
| -02 Drop Area | -11 No Carts |
| -03 Next Tee (with one way arrow) | -12 Keep Carts 30' From Green |
| -04 Please Repair Ball Marks | -13 No Chipping |
| -05 Please Replace Divots | -14 Please Observe 90° Rule |
| -06 Please Rake Bunkers | -15 Putting Green Closed |
| -07 Please Keep Off | -16 Driving Range Closed |
| -08 Carts (with one way arrow) | -17 Chemicals Applied Today |
| -09 Keep Carts On Path | -18 Customized Signs |



[36171]



[36172]



[05]



[06]



[07]



[08]



[09]



[10]



[11]



[12]



CUSTOM SIGNS

If you don't see the signs you need on our catalog, we will customize one for you. Just tell us what you want or you can design your signs and let us do all the rest.

Order information:
3617C Custom Signs



[01]



[02]



[03]



[04]

PLASTIC NTP/LONG DRIVE MARKERS

Manufactured from Green/white Laminated plastic with high transparent acrylic cover. Weather resistant. NTP marker unit may contain a built-in tape measure 10m(33ft)as required allowing you to measure from ball-to-cup easily. stainless steel spike Cards easily slide in and out from side window. Size: 275mm H x 165mm W plus spike

Order information:

- 3910** NTP Marker without Tape Measure
- 3910TM** NTP marker with Tape Measure
- 3920** Long Drive Marker

STAINLESS STEEL LONG DRIVE /NTP MARKERS

Sturdy stainless steel frame that hold 4 cards.15cmW x20cmH plus spike

Order information:

- 32231** Long Drive/NTP marker1
- 32232** Long Drive/NTP marker2

NTP/LONG DRIVE CARD PACKS

25 pcs each pack, fit 3910, 3910TM,3920,32231and 32232

Order information:

- 32233N** NTP cards (25pcs)
- 32233L** Long Drive cards (25pcs)

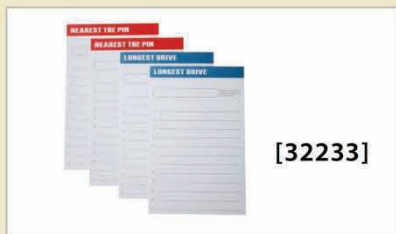

[32233]

CUSTOM MARKER

If you don't see the signs you need on our catalog, we will customize one for you. Just tell us what you want or you can design your signs and let us do all the rest.

- Ordering information:
CNTP Custom Marker



[3910]



Back View Of 3910TM



[3920]



[32231]



[32232]

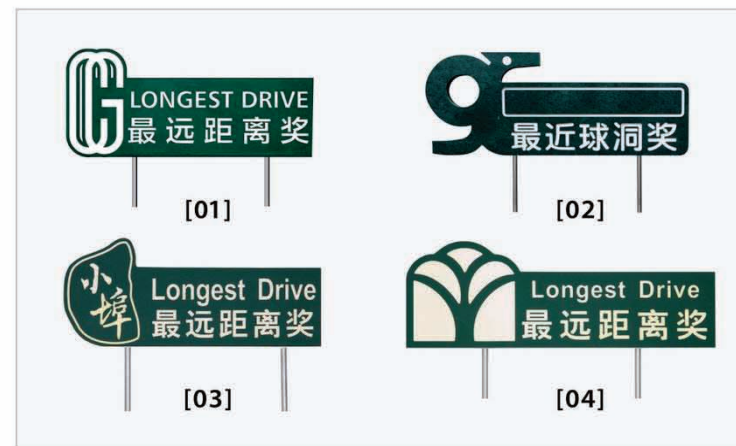

[01]

[02]

[03]

[04]

[CNTP]

GOLF COURSE SIGNS

- Choose our recycled plastic or laminated plastic to make the signs.
- Recycled plastic post: many sizes available for posts, Please see page 34 to choose post from our wide selection of posts.
- Color: Posts stocking colors are green, brown, other colors are available upon request.



[3611SA]



[3611SB]



Sign size (SA): 14" W x 12"H (35cm x 30cm)
 Sign material: Either recycled plastic (Color: Green, Brown, Black) or Green/Beige laminated plastic
 Please refer to Post Chart to choose the post you need.

Order Information:

- 3611SA1**— Recycled Plastic Sign (Green)
 - 3611SA2**— Recycled Plastic Sign (Brown)
 - 3611SA3**— Recycled Plastic Sign (Black)
 - 3611SA4**— Green/Beige Laminated Plastic
- (Please specify sign message above or design your own signs)

Sign size (SA): 14" W x 18"H (35cm x 45cm)
 Sign material: Either recycled plastic (Color: Green, Brown, Black) or Green/Beige laminated plastic
 Please refer to Post Chart to choose the post you need.

Order Information:

- 3611SB1**— Recycled Plastic Sign (Green)
 - 3611SB2**— Recycled Plastic Sign (Brown)
 - 3611SB3**— Recycled Plastic Sign (Black)
 - 3611SB4**— Green/Beige Laminated Plastic
- (Please specify sign message above or design your own signs)

GOLF COURSE SIGNS (Cont.)

- Choose our recycled plastic or laminated plastic to make the signs.
- Recycled plastic post: many sizes available for posts, Please see page 34 to choose post from our wide selection of posts.
- Color: Post stocking colors are green, brown, other colors are available upon request.

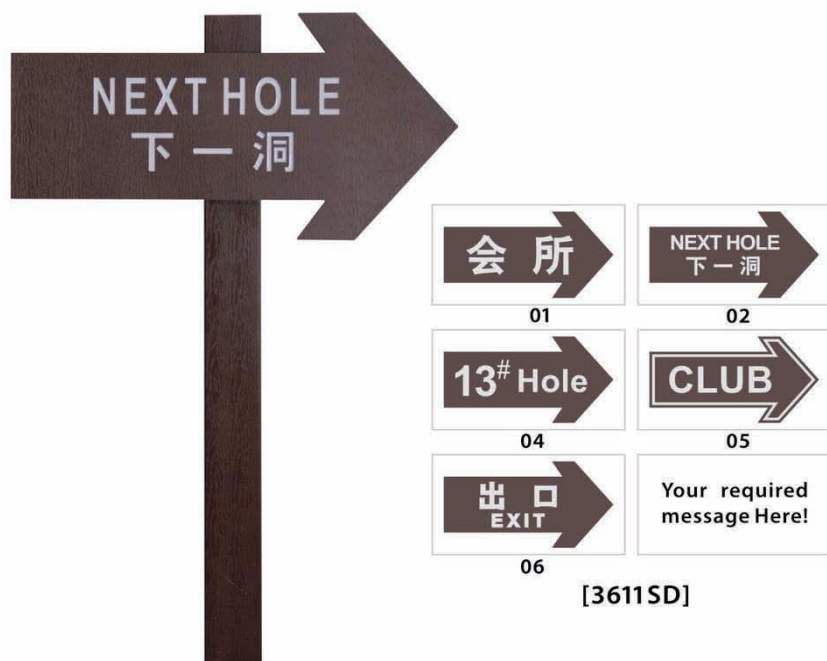

Sign size (SA): 21" W x 11" H (54cm x 28cm)
 Sign material: Either recycled plastic (Color: Green, Brown, Black) or Green/Beige laminated plastic
 Please refer to Post Chart to choose the post you need.

Order Information:

- 3611SD1** -__ Recycled Plastic Sign (Green)
- 3611SD2** -__ Recycled Plastic Sign (Brown)
- 3611SD3** -__ Recycled Plastic Sign (Black)
- 3611SD4** -__ Green/Beige Laminated Plastic
 (Please specify sign message above or design your own signs)



Sign size (SA): 15" W x 8" H (38cm x 20cm)
 Sign material: Either recycled plastic (Color: Green, Brown, Black) or Green/Beige laminated plastic
 Please refer to Post Chart to choose the post you need.

Order Information:

- 3611SC1** -__ Recycled Plastic Sign (Green)
- 3611SC2** -__ Recycled Plastic Sign (Brown)
- 3611SC3** -__ Recycled Plastic Sign (Black)
- 3611SC4** -__ Green/Beige Laminated Plastic
 (Please specify sign message above or design your own signs)

GOLF COURSE SIGNS (Cont.)

- Choose our recycled plastic or laminated plastic to make the signs.
- Recycled plastic post: many sizes available for posts, Please see page 34 to choose post from our wide selection of posts.
- Color: Post stocking colors are green, brown, other colors are available upon request.



[3611SE]

Sign size (SA): 16" W x 13" H (40cm x 33cm)
 Sign material: Either recycled plastic (Color: Green, Brown, Black) or Green/Beige laminated plastic
 Please refer to Post Chart to choose the post you need.

Order Information:

- 3611SE1**-__ Recycled Plastic Sign (Green)
- 3611SE2**-__ Recycled Plastic Sign (Brown)
- 3611SE3**-__ Recycled Plastic Sign (Black)
- 3611SE4**-__ Green/Beige Laminated Plastic
 (Please specify sign message above or design your own signs)



[3611SF]

Sign size (SA): 17" W x 23" H (43cm x 58cm)
 Sign material: Either recycled plastic (Color: Green, Brown, Black) or Green/Beige laminated plastic
 Please refer to Post Chart to choose the post you need.

Order Information:

- 3611SF1**-__ Recycled Plastic Sign (Green)
- 3611SF2**-__ Recycled Plastic Sign (Brown)
- 3611SF3**-__ Recycled Plastic Sign (Black)
- 3611SF4**-__ Green/Beige Laminated Plastic
 (Please specify sign message above or design your own signs)



GOLF COURSE SIGNS (Cont.)

FRAME SIGNS

- Decorative Frame is constructed from 100% recycled plastic, holds 18"W X 24"H sign.
- Two-tone color construction. you can choose your own color combination, please refer to page 25 for details.

Sign Size: 18"W X 24"H (46cm X 61cm)
 Frame Size: 23"W X 96"H (580 X 244cm)

Order Information:
3601DS Frame Sign



[3601DS]



[3611CR]



[3611KP]



[3650]



PACE OF PLAY SIGNS

Remind golfer to keep up the pace, come with 10.5" clock. Please specify color when ordering.

Sign Size: 15"W X 24"H (38cm X 61cm)

Order information:
3611KP Pace of Play Sign

TODAY'S COURSE RULES SIGNS

Inform golfer of change in the course condition, come with 10.5" clock. Please specify color when ordering.

Sign Size: 15"W X 24"H (38cm X 61cm)

Order information:
3611CR Today's Course Rules Sign

BAG DROP SIGN

Portable sign for easy movement. Aluminium base and post, powder coated. Recyclable plastic sign face with engraved letters.

Order information:
3650 Bag Drop Sign



[3625]

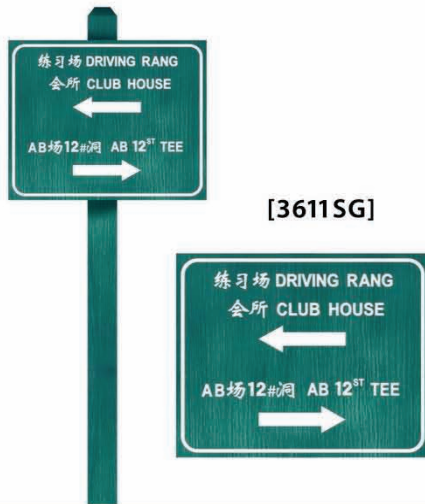

[3611SG]

INTERCHANGEABLE COURSE SIGNS

- Made with recycled plastic.
- Engraved sign message and interchangeable individual numbers.
- Set the distance to the pin or establish other usages you see fit.

3625 Interchangeable Course Signs

COURSE SIGNS

Sign size : 330mmHX400mmW

Please refer to Post Chart to choose the post you need.

3611SG-__ (Please refer to page 31 to 33 for signs material and colors)

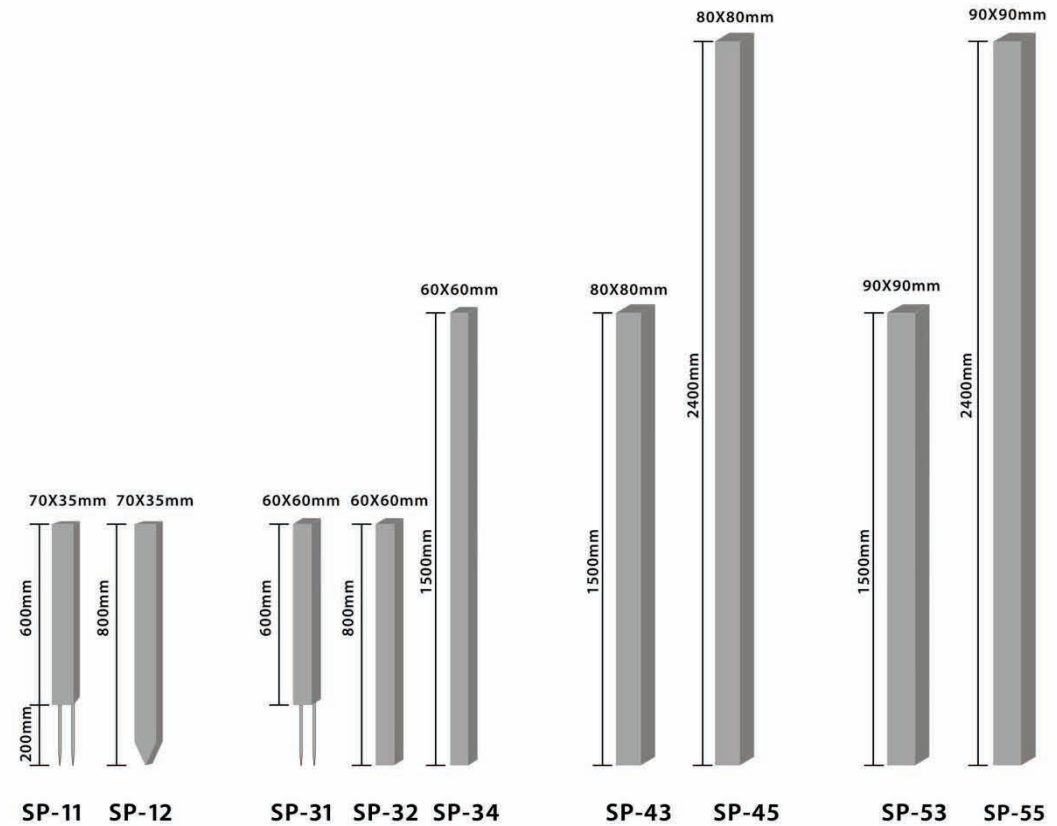

[AVAILABLE POST OPTIONS]

SIGN POST OPTIONS

- Recycled plastic post.
- Stock color: Green, Brown.
- Other color can be customized, please specify color when ordering.

Order Information:

SP-11 70mmx35mmx600mm plus two stainless steel (200mm long)

SP-12 70mmx35mmx800mm with point end

SP-31 60mmx60mmx600mm plus two stainless steel (200mm long)

SP-32 60mmx60mmx800mm

SP-34 60mmx60mmx1500mm

Order Information (Cont.):

SP-43 80mmx80mmx1500mm

SP-45 80mmx80mmx2400mm

SP-53 90mmx90mmx1500mm

SP-55 90mmx90mmx2400mm

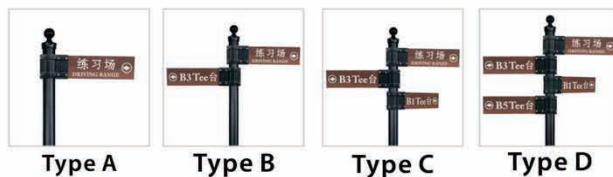

Type A Type B Type C Type D

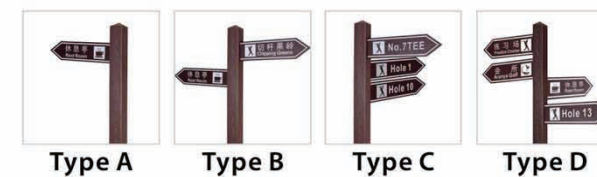

Type A Type B Type C Type D

ALUMINIUM FINGER POST SIGNS

- 3"(76mm) round decorative post with fluted base. The sign post, fluted base and signs mounting bracket are all cast aluminium and powder coated finish.
- Signs are made from recycled plastic, engraved message and poured. Choice of sign colors: green, brown and black.
- Arms can be positioned in any direction.
- Number of arms to choose from: one or more arms.
- Arm style can be flat head or arrow head.

Order Information:

- 3621FPA** Type A (come with one arm)
- 3621FPB** Type B (come with two arms)
- 3621FPC** Type C (come with three arms)
- 3621FPD** Type D (come with four arms)
- 3621FPP** Custom type (come with four more arms)

RECYCLED PLASTIC FINGER POST SIGNS

- These Finger Post Signs are made from recycled plastic.
- Post size: 9 cm x 9 cm x 240 cm.
- Signs primary colors: green, brown and black.
- Arms can be positioned in four different direction.
- Number of arms to choose from: one or more arms.
- Arm style can be flat head or arrow head.

Order Information:

- 3618A** Type A (come with single direction sign)
- 3618B** Type B (come with two direction signs)
- 3618C** Type C (come with three direction signs)
- 3618D** Type D (come with four direction signs)



[3621H]

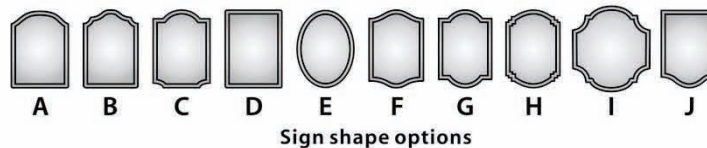

Sign shape options



HANGING

SIDE

FACE

DOUBLE SIDE



[3621CF]



[3621CD]

ALUMINIUM DECORATIVE POST TEE SIGNS

- 3" (7.6cm) round decorative post with fluted base. The sign post, fluted base and mounting bracket are all cast aluminium and powder coated finish.
- Engraved Tee signs with logo, hole number, par, up to (5) yardages & hole layout map.
- Signs are available in different sizes and shapes, see below.
- Please refer to page 43,44 and 45 to select sign material you need.
- You can design your own sign, and let us do the rest.
- Come with one 28" underground mounting anchor for easy installation.

Order information:

- 3621H Decorative Post Tee Signs-Hanging
- 3621S Decorative Post Tee Signs-Side
- 3621F Decorative Post Tee Signs-Face
- 3621D Decorative Post Tee Signs-Double Side



ALUMINIUM DECORATIVE POST COURSE SIGNS

- 3" (7.6cm) round decorative post with fluted base. The sign post, fluted base and mounting bracket are all cast aluminium and powder coated finish.
- Engraved message and poured.
- Signs are available in different sizes and shapes, see below.
- Please refer to page 43,44 and 45 to select sign material you need.
- You can design your own sign, and let us do the rest.
- Come with one 28" underground mounting anchor for easy installation.

Order information:

- 3621CH Decorative Post Course Signs-hanging
- 3621CS Decorative Post Course Signs-Side
- 3621CF Decorative Post Course Signs- Face
- 3621CD Decorative Post Course Signs – Double Side

RECYCLED PLASTIC TEE SIGNS

- Constructed totally from recycled plastic, including construction posts and signs. Maintenance free, no painting, fade resistance. These signs are durable, will perform year after year under heavy-use, indoors or outdoors, won't split or crack.
- Many construction styles you can choose from:

Single Post Style:

- Podium style (P)
- Face Sign style (F)
- Single-sided sign style (SS)
- Double-sided signs style (DS)

Two-Post Style:

- Sponsored horizontal style (SH)
- Sponsored vertical style (SV)
- Decorating vertical style (DV)

- Engraved Tee signs with logo, hole number, par, up to (5) yardages & hole layout map.
- Signs are available in different sizes and shapes, please see page 36 for shape options.
- You can design your own sign, and let us do the rest.

Order information:

SINGLE POST TEE SIGNS:

- 36PP1-P** Podium Style
- 36PP1-F** Face Sign style
- 36PP1-SS** Single-sided mounting sign style
- 36PP1-DS** Double-sided mounting signs style

TWO-POST TEE SIGNS:

- 36PP2-SH** Sponsored horizontal style
- 36PP2-SV** Sponsored vertical style
- 36PP2-DV** Decorating vertical style

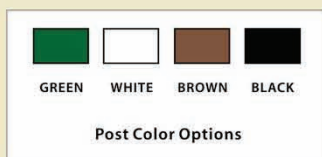

[36PP1-P]



[36PP1-F]



[36PP1-DS]



[36PP2-SH]



[36PP2-SV]



[36PP2-DV]



[36PS1-P]



[36PS2-V]



[36PS2-SV]



[3631]



[3632]



[3634]

"POLYSTONE" TEE SIGNS

- The sign is made from "Polystone" which is, as an option to granite, a material used for kitchen counter tops. This material can be cut, shaped and engraved with detailed graphics, offers functional beauty and design potential.
- Many construction styles you can choose from: Please see page 37.
- Recycled plastic post.
- Engraved Tee signs with logo, hole number, par, up to (5) yardages & hole layout map.
- Signs are available in different sizes and shapes, please see page 36 for shape options.
- You can design your own sign, and let us do the rest.

Order information:

SINGLE POST TEE SIGNS:

36PS1-P Podium Style

TWO- POST TEE SIGNS:

36PS2-V Vertical style

36PS2-SV Sponsored vertical style

GRANITE TEE SIGNS

Grey granite base with polished black granite sign face.

Order information:

3631 Granite Tee Signs

UPRIGHT GRANITE TEE SIGNS

- Granite base with logo, recycled plastic sign
- 100cm height.

Order information:

3632 Upright Granite Tee Signs

SINGLE POST TEE SIGNS

- Recycled plastic wood post
- Size: 16"W x 5"D x 95"H (40.5cm X 12.7cm x241cm)
- Engraved laminated plastic Tee signs with logo, hole number, par, up to (5) yardages & hole layout map.

Order information:

3634 Single Post Tee Signs

LAMINATE PLSTIC SIGNAGE

A new solution for customer to design their course signs , tee signs.

Our dual-colored laminate is precision machined to create well-contrasting message whether it's showing yardages, course maps, rules, or whatever is pertinent.

Nearly any shape, configuration or design can be create with our laminate plastic, and adding our many standard color resin finish or customer resin color, the possibilities are endless.

Maintenance-free, weather-resistant.

GREEN/WHITE LAMINATE TEE SIGNS

Signs: Engraved Tee signs with logo, hole number, par , up to (5) yardages & hole layout map. Many sizes and shapes are available for selection, please below.

Post/Frame: Many construction styles you can chose from:

Single Post Style:

- Aluminium Decorative Post
- Face Sign style (F)
- Single-sided sign style (SS)
- Double-sided signs style (DS)

Two-Post Style:

- Sponsored Vertical style (SV)
- Vertical style (V)

Order information:

SINGLE POST TEE SIGNS:

- 3621H** Aluminium Decorative Post
- 36PD1-F** Face Sign style
- 36PD1-SS** Single-sided mounting sign style
- 36PD1-DS** Double-sided mounting signs style

TWO- POST TEE SIGNS:

- 36PD2-SV** Sponsored Vertical style
- 36PD2-V** Vertical style



Sign shape options



[3801]

SINGLE POST TEE SIGNS

- 9 x 9cm recycled plastic post, 81cm long plus two stainless steel spikes.
- Granite or acrylic plaque recessed down.

3801 Single Post Tee Sign

ENTRANCE SIGNS

- Recycled plastic frame with well designed graphics creates the right kind of impression.
- The central sign panel can be made from recycled plastic, dual-color laminate or combination of material.
- size: 240cm H x 130cmW

3600 Entrance Sign

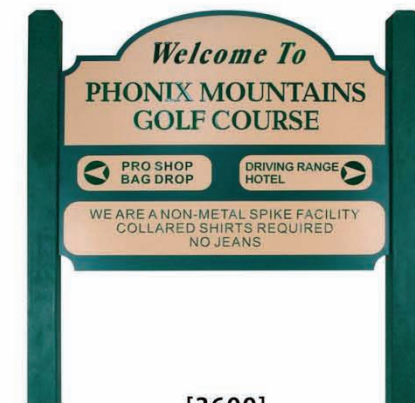

[3600]



[3681]



[3680]



[36831]



[36832]

INTERCHANGEABLE COURSE INFORMATION SIGNS

- Made from the same durable material used for kitchen counter tops, this material can be shaped and engraved to your needs.
- Can be mounted either on the wall or on the post.
- Interchangeable plaques slide into aluminium channels to create everyday information.

Order information:
3680 Interchangeable Course Information Sign

CLUBHOUSE SIGNS

- Made from the same durable material used for kitchen counter tops, this material can be shaped and engraved to your needs.
- Can be mounted either on the wall or on the post.
- The finish is high quality and can be customized with your own design.

Order information:
3681 Clubhouse Signs

INFORMATION AND NOTICE SIGN

- Big size (122cmX 176cm).
- Mounted on the wall, suitable for indoor or outdoor use
- Interchangeable plaques slide into aluminium channels to create everyday information.

Order information:
36831 Information and Notice Sign

CLUB TARIFF SIGN

- Big size (122cmX 176cm).
- Mounted on the wall, suitable for indoor or outdoor use.
- Interchangeable plaques slide into aluminium channels to create everyday information.

Order information:
36832 Club Tariff Sign



[368CS]



INFORMATION AND NOTICE SIGNS

- Constructed completely from recycled plastic lumber, any size can be customized to meet your requirements.
- UV printed signs are suitable for outdoor use, any information can be printed on the sign face, especially good for picture printing
- Long lasting and maintenance free.
- Customized signs: you can either chose style of signs from the signs listed above, or design your own signs and let us do all for you.

Order information:
368CS Information and Notice Sign





[2510]



[2511]



[3660]



[3151]



[3185]



[3181]

PORTABLE COURSE SIGNS

- Portable for easy movement.
- Made from laminated plastic, engraved message on either single side or double sides.
- 50cm wide and 45cm high.

Order information:

3660S Portable Course signs -Single side

3660D Portable Course Signs- Double

EASEL SIGNS

- Simple folding construction.
- Interchangeable yardage number.
- 10.5" weather proof clock with celsius thermometer.

Order information:

2510 Easel Sign-Driving Range -LW

2511 Easel Sign-Driving Range -HD

3151 Easel Sign-Clock

3181 Easel Sign-Clock

3185 Easel Sign-Clock

CLOCK

10.5"(26.7 cm) WEATHER PROOF, come with celsius thermometer.

Order information:

31511 Clock

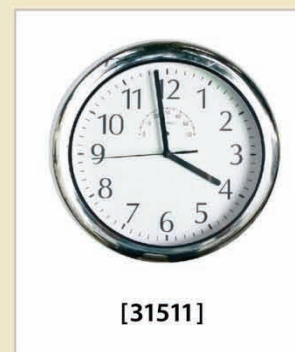

[31511]

DUAL-COLOR EASEL SIGNS

- Simple folding construction.
- Interchangeable yardage number.
- 10.5" weather proof clock with celsius thermometer.
- Please specify color or color combination when ordering, please refer to page 26 for details.

Small Size: 17" x 28" (43cm x 72cm)
 Medium Size: 21" x 34" (53cm x 86cm)

Order information:

2518M1-DR Easel Sign-Driving Range -Medium Size

2518M2-DR Easel Sign-Driving Range -Medium Size

3186S1-TM Easel Sign-Clock -Small Size

3186S2-TM Easel Sign-Clock -Small Size

3186M2-TT Easel Sign-TT- Medium Size

3186M2-BD Easel Sign-BD- Medium Size

CLOCK

10.5" (26.7 cm) WEATHER PROOF.
 come with celsius thermometer.

Order information:

31511 Clock



[31511]



[2518M1-DR]



[2518M2-DR]



[3186S1-TM]



[3186S2-TM]



[3186M2-TT]



[3186M2-BD]



[3401]



[3480]



[4420]



[4410]

PORTABLE PODIUM

- This Portable Podium is made from recycled plastic with hinged top and storage underneath. Easily moves to wherever needed.
- Available color option: Green, Brown and Black, Please specify color when ordering.
- Size: 25-1/2"W x 13-1/2"D x 43"H (65cm x 35cm x 110cm)

Order information:

3401 Portable Podium

CADDIE EVALUATION BOX

- This Caddie Evaluation Box is designed for Caddie Master to collect evaluation cards signed by Golfer.
- Made from recycled plastic with lockable hinged top and four separated storage tank underneath. Each storage tank marked on its top with rating symbol or words, such as Excellent, Good, Fair, and Poor separately.
- Available color option: Green, Brown and Black, Please specify color when ordering.
- Size: 25-1/2"W x 13-1/2"D x 43"H (65cm x 35cm x 110cm)

Order information:

3480 Caddies Evaluation Box

PODIUMS

- Constructed from 100% recycled plastic, maintenance free.
- Come with hinged top and storage underneath. Pencil stop.
- Two hinged back doors for additional storage.
- Please specify color or color combinations, refer to page 26 for details.

Order Information:

4410 Tournament Podium
Size: 26-1/3"W x 21"D x 44"H (67cm x 53cm x 112cm)

4420 Tournament Podium (Flat Top)
Size: 26-1/3"W x 21"D x 44"H (67cm x 53cm x 112cm)



[Back View]





[4440]



[4430]

PODIUMS **NEW**

- Constructed from 100% recycled plastic, maintenance free.
- Hinged back doors for additional storage.
- Please specify color or color combinations, refer to page 26 for details.

Order Information:

- 4430** Tournament Podium (Flat Top)
 Size: 26-1/3"W x 21"D x 44"H (67cm x 53cm x 112cm)
- 4440** Tournament Podium (Flat Top)
 Size: 76"W x 21"D x 44"H (193cm x 53cm x 112cm)



[Add Your LOGO]



[Back View]



[4510]



Internal Cup Dispenser

Cups are conveniently tucked inside to the left of the water cooler for ease of use and neat storage.



[3560]



[3570]



[4520]



[4610]



[4620]

WATER COOLER ENCLOSURES

WATER COOLER-4510

- Water cooler enclosure mounted on the post
- Constructed from maintenance-free plastic, lockable rear door.
- Hold 5 Gal.(19L) water cooler(sold separately), includes cup dispenser.
- Mounting post is 6" X 6" X 60" recycled plastic.
- Two-tone color construction, you can choose your own color

COMBINATION STATION-4520

This enclosure accommodates a 5 Gal. water cooler on top (sold separately) and a 16 Gal.(60L) trash liner (included) on the bottom. Internal cup dispenser included, lockable rear door. Two-tone color construction, you can choose your own color combination. please refer to page 26 for details.



- Order information:
- 4510** Water Cooler
22"W * 22"D*41"H
(56cm* 56cm*104cm)
 - 4520** Combination Station
22"W * 22"D*74"H
(56cm* 56cm*188cm)
 - 3560** 5 gallon (19 L) Cooler
 - 3570** Cup Dispenser

COOLER BOXES

Constructed from maintenance free recycled plastic
Come complete with a removable 60L cooler
Please specify color or color combination.



- Order information:
- 4610** Cooler Box (Low-profile)
31"W * 22"D*18"H
(79cm* 56cm*46cm)
 - 4620** Cooler Box
31"W * 22"D*30"H
(79cm* 56cm*76cm)

LOTUS BALL WASHER

- Cast from durable, rust free aluminium;
- Internal parts are stainless steel and high strength plastic;
- Simple design, only one moving part;
- Mount to standard 2-3/8"(6cm)O.D. pipe;
- All replacement parts are available;
- Stock colors: red, green & black.

Order information

- 301R** Lotus Ball Washer-Red
- 301G** Lotus Ball Washer-Green
- 301B** Lotus Ball Washer-Black



[301G]



BALL WASHER CONSOLE UNITS

For your convenience, here are some ball washer console units. Pick one of our popular packages, or create your own packages by yourself with different combination. you can even pick the color!



UNIT 1



UNIT 2



UNIT 3

BALL WASHER CONSOLE UNIT1

Order information

- 3101R** Unit 1-Red
- 3101G** Unit 1-Green
- 3101B** Unit 1-Black

BALL WASHER CONSOLE UNIT2

Order information

- 3102R** Unit 2-Red
- 3102G** Unit 2-Green
- 3102B** Unit 2-Black

BALL WASHER CONSOLE UNIT3

Order information

- 3103R** Unit3-Red
- 3103G** Unit3-Green
- 3103B** Unit3-Black

WASTE MATE TRASH RECEPTACLES

- Durable polyethylene, no rust, no dent.
- The bottom container is available in (3) colors: Red, Green & Black. And the lid color is black only.
- Capacity: 9 gal. (34 liter)
- Designed to stack for shipping.
- Please specify lid style when ordering.

Order information

- 3050R** Waste mate-Red
- 3050G** Waste mate-Green
- 3050B** Waste mate-Black
- 30501** Trash Lid
- 30502** Solid Lid

Lid Options



Trash Opening
[30501]

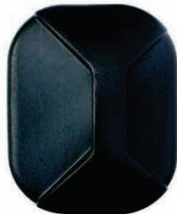

Solid
[30502]

WASTE MATE POLE MOUNTING KIT

Made of aluminium alloy.
Surface anodized black.

Order Information

- 3061** Single Unit Pole Mount Kit
(All three pieces including hardware)
- 30611** Hoop Frame
- 30612** Mounting Bracket
- 30613** Back Clamp
- 3062** Double Unit Pole Mount Kit
(All four pieces including hardware)



[3050]

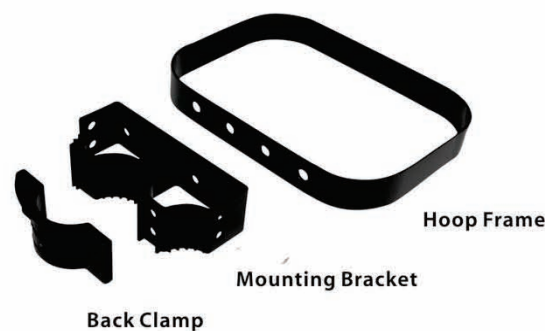

[3061]



[3062]

BALL WASHER ACCESSORIES



[3001G]



[31631G]



[31632G]



[30021]

[30022]



[3010]



[3000]

ALUMINIUM BASE

Cast aluminium, 18" (46cm) dia. spikes included for stability.

Order Information

3001R Red

3001G Green

3001B Black

MOUNTING PIPE

2-3/8" (6cm) O.D aluminium pipe. Powder-coated black finish.

Order Information

30021 34 inch (87cm) long

30022 48 inch (122cm) long

BALL WASHER BRACKET

Mount ball washer to any flat surface. Powder coated black aluminium.

Order Information

3010 Ball Washer Bracket

TEE TOWELS

- 100% cotton tee towels.
- 18"×18" (46cm×46cm) size with brass grommet.
- Two styles for your choice:
 - Trifold with central grommet
 - Twifold with corner grommet

Order information

31631G Trifold-Green

31631B Trifold-Black

31632G Twifold-Green

31632B Twifold-Black

BALL WASHER REPAIR KIT

Order information:

Ball Washer Repair Kit

3000 complete kit



CUSTOM TEE CONSOLE

This Tee Console includes 10 gallon waste enclosure , a ball washer and custom signage. We can offer custom tee consoles with tee signs and logo application. Call for details.

Order information
36CTS Custom Tee Console

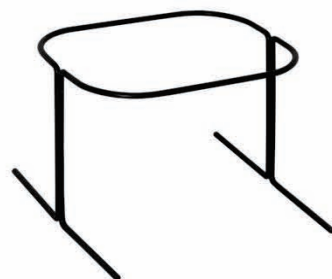

[3070]



[3071]



[3081]



[3082]

WASTE MATE STANDS

Steel bracket with two stands makes the trash mate freestanding on the ground. Steel bracket with double spikes keeps the trash mate in place

Order information
3070 Low Stand
3071 Spiked Stand

WASTE MATE TRASH BINS

The combination of Waste Mate Trash receptacle and Waste mate Stands make the Waste Mate freestanding anywhere they are needed.

Order information
3081 Low Stand Trash Bin
3082 Spiked Stand Trash Bin
 (Please specify colors when ordering.)



[4720]



[4710]



[4750]



[4760]

TRASH CONTAINERS

- Constructed from maintenance free recycled plastic
- Come with a removable plastic bucket.
- Please specify color or color combination when ordering, please refer to page 26 for details.

Order information:

- 4710** Top Load (60L Single)
19"W * 19"D*26"H
(49cm* 49cm*66cm)
- 4720** Top Load (90L Single)
21-3/5"W * 21-3/5"D*21"H
(55cm* 55cm*54cm)
- 4750** Side Load (60L Single)
19"W * 19"D*34"H
(49cm* 49cm*86cm)
- 4760** Side Load (60L Single)
20"W * 20"D*39"H
(51cm* 51cm*99cm)



Ashtray Option:
Stainless steel ashtrays:



S-ASH1
6-8/9"W x 6-2/5"D x 2-3/5"H
(17.5cmW x 16.2cmD x 6.6cmH)



S-ASH2
5" Dia x 2"H
(12.5cmDia x 2.5cmH)



[4850]



[4860]

TRASH CONTAINERS

- Constructed from maintenance free recycled plastic
- Come with a removable plastic bucket.
- Please specify color or color combination when ordering, please refer to page 26 for details.

Order information:

4850 Side Load (60L Double)
37"W * 19"D*34"H
(94cm* 49cm*86cm)

4860 side Load (60L Double)
38.5"W *20"D*38.5H
(98cm*51cm*98cm)

NEW



Front Doors Opening

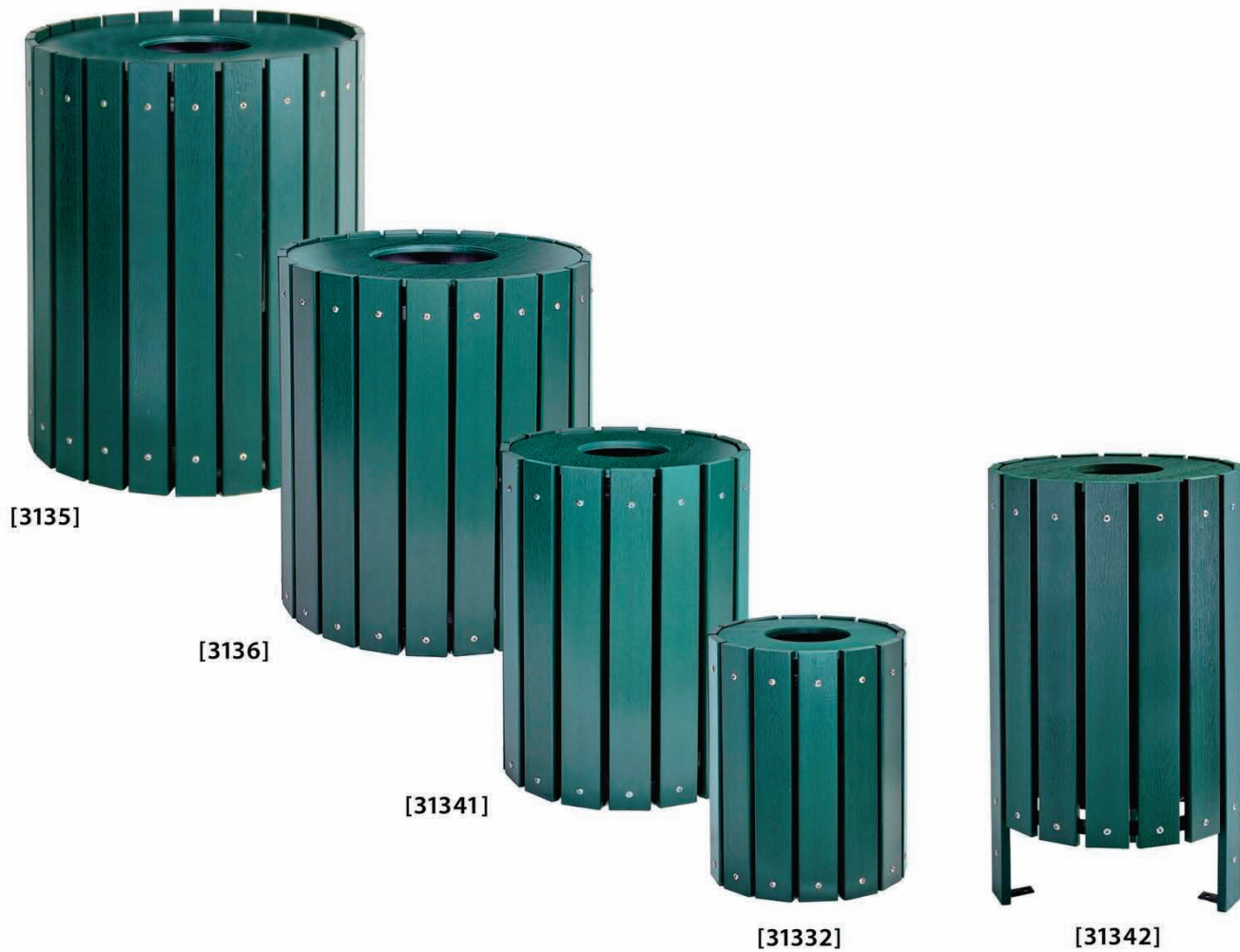

ROUND TRASH CONTAINER

Recycled plastic-wood slats are rustproof, fade resistant and maintenance free.

Plastic bucket can be removed easily for dumping.

Come with a lid and bucket.

Stock color: Green, Brown and black. please specify color when ordering.

Order information:

31332 5 gallon(20 liter)
13-4/5"Dia. * 17-1/2"H
(35cmDia.* 45cmH)

31341 10 gallon(40 liter)
16"Dia. * 24"H
(41cmDia * 61cmH)

31342 10 gallon (40 liter)
16"Dia. * 28-7/9"H
(41cmDia. * 73cmH)

3135 24 gallon (90 liter)
21"Dia. * 29"H
(53cmDia. * 74cmH)

3136 19 gallon(70 liter)
Size:21"Dia. * 25-1/2"H
(53cmDia. * 65cmH)



SQUARE TRASH CONTAINERS

Recycle plastic-wood slats are rustproof, fade resistant and maintenance free. Plastic bucket can be removed easily for dumping. Come with a lid and bucket. Stock color: Green, Brown. please specify color when ordering.



[31331]



[3139]



[3137]



[3138]

Order information:

- 31331** 5 gallon(20 liter)
12-3/5"W * 12-3/5"D * 17-1/2"H
(32cmW * 32cmD * 45cmH)
- 3137** 10 gallon(40 liter)
19"W * 15"D * 32"H
(48cmW * 38cmD * 81cmH)
- 3138** 10 gallon(40 liter)
21-1/3"W * 21-1/3 "D * 42"H
(54cmW * 54cmD * 107cmH)
- 3139** 16 gallon (60 liter)
18-1/2"W * 18-1/2"D * 24"H
(47cmW * 47cmD * 61cmH)





[31411]



[31412]



[3147]



[31431]



[31432]

RECYCLED PLASTIC DIVOT MIX BOX

Made from recycle plastic-wood slats. Plastic bucket can be removed easily for dumping.

Come with a lid and plastic bucket. Stock color: Green, Brown and black. please specify color when ordering.

Order information:

31431 5 gallon(20 liter)
12-3/5"W*12-3/5"D*17-1/2"H
(32cmW * 32cmD * 45cmH)

31432 5 gallon(20 liter)
13-4/5"Dia.*17-1/2"H
(35cmDia.*45cmH)

31411 6 gallon(23 liter)
21-2/3"W*16-3/5"D*25-3/5"H
(55cmW*42cmD*65cmH)

31412 6 gallon (23 liter)
21-2/3"W*16-3/5"D*13-3/5"H
(55cmW*42cmD*35cmH)

3147 16 gallon (60 liter)
20"W*20"D*26"H
(50cm*50cm*65cm)



SMALL DIVOT BOXES

Made completely from recycled plastic.
Please specify color or color combinations
when ordering, please refer to page 26 for
details

Order information:

31430 14"W*14"D*12-3/5"H
(35cm * 35cm * 32cm)

5110 20"W*12"D*12"H
(51cm * 30cm * 30cm)

5120 20"W*12"D*27"H
(51cm * 30cm * 68cm)



[5220]



[31430]



[5110]

DIVOT BOTTLE BOXES

Made completely from recycled plastic.
Please specify color or color combinations
when ordering, please refer to page 25 for
details

Order information:

5220 32"W*24"D*24"H
(81cmW * 61cm * 61cm)

5230 45"W*25"D*32"H
(114cm * 64cm * 81cm)



[5230]



[5120]



[6110]



[5150]



[31441]



[31442]

PLANTER/DIVOT MIX BOX

Constructed with recycle plastic which are rustproof fade resistant and maintenance free . Please specify color when ordering .

Order information:

- 6110** Planter Box
size: 22"W *22"D *23"H
(56cm*56cm*58cm)
- 5150** Divot mix storage container
No bucket inside.
size: 21-3/5"W *21-3/5"D *21"H
(55cm*55cm*54cm)

DIVOT MIX STORAGE CONTAINERS

Storage containers offer an ample room for storing divot mix, range balls or whatever you see fit.

Constructed with recycle plastic-wood which are rustproof fade resistant and maintenance

Order information:

- 31441** Divot mix storage container- Small
size: 20"W *16"D *25"H
(51cmW*41cmD*64cmH)
- 31442** Divot mix storage container- Large,
size: 31"W *20"D *29"H
(79cmW*51cmD*74cmH)

Constructed with recycled plastic. Rustproof, fade resistant and maintenance free. Please specify color when ordering.

Color Options



STORAGE BOX

- This durable box can be used to store anything from golf range ball to Divot Mix.
- Two-tone color construction, you can choose your own color combination, please refer to page 26 for detail.

Order information:

5510 Storage Box
Size: 36"Wx24"Dx31"H
(91cmX61cmX79cm)

5520 Storage Box
Size: 40"Wx31.5"Dx31"H
(100cmX80cmX79cm)

NEW

RANGE BALL STORAGE BOX

- This unit is perfect for storage of golf balls up to 5000pcs.
- Dual top lids open easy access.
- Size: 38-1/2"Wx26-3/4"Dx29"H
(98cmWX68cmDX74cmH)

Order information:

3432 Range ball storage box

RANGE BALL UTILITY CART

- A heavy duty frame construction give this cart a sturdy build, while its recycled plastic panels provide a classic look.
- Ideal for transport or storage of golf range ball up to 5000pcs.
- Size: 38-1/2"Wx26-3/4"Dx30"H
(98cmLX67cmWX76cmH)

Order information:

3433 Range ball utility cart



[3433]



[3432]



[5510]



[5520]



[31940]



[31900]



[31910]



[31930]

TRASH CONTAINER/ DIVOT MIX BOX COMBINATIONS

These unique promote convenience and create a great look to your golf course. Constructed with recycled plastic-wiid which are rustproof , fade resistant and maintenance free.. Each unit come with two plastic buckets except for unit 31940

Order Information:

- 31900** Combination 1
16 gallon (60 liter) trash and
16 gallon (60 liter) divot buckets inside.
Size: 36-3/5"W * 18-1/3"D * 27-2/5"H
(93cmW * 47cmD * 70cmH)
- 31910** Combination 2
10 gallon (40 liter) trash and
10 gallon (40 liter) divot buckets inside.
Size: 38"W * 15"D * 32"H
(96cmW * 38cmD * 81cmH)
- 31930** Combination 4
10 gallon (40 liter) trash and
16 gallon (60 liter) divot buckets inside.
Size: 39"W * 21-1/3"D * 42"H
(100cmW * 54cmD * 107cmH)
- 31940** Combination 5
24gallon(90liter) plastic trash bucket.
No divot buckets inside.
Size: 44"W * 44"D * 22"H
(110cmW * 110cmD * 54cmH)

DRAW STRAWS

- This useful tool help you to decide the honor who is to play first form teeing ground or in schedule order.
- Made of entirely aluminium alloy and anodized surface.
- Plastic stake included.

3152R Draw Straws-red

3152B Draw Straws-Blue

TEE HOLDER

- 30cm Dis. aluminium or plastic board holds a hundred tees.
- 100cm aluminium post plus stainless steel stake.
- A great addition to any tee area.
- Your course's name, logo can be added on the center of board.

3154 Tee Holder

SCORECARD CADDY

- Made from recycled plastic, rust proof, fade resistant and maintenance free.
- Three compartments for scorecards, pencils and tees.
- 9cm*9cm*150cm recycled plastic post included.
- Color: green and brown.
- Size: 42cmW*37cmD*12.5cmH (not include post)

3155 Scorecard Caddy

Please specify color when ordering.

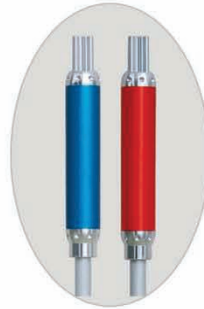

[3152]

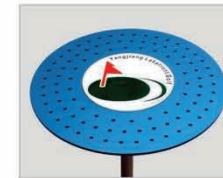

[3154]



[3155]

BROKEN TEE CADDY

Recycled plastic lumber caddy. 4"(10cm) high with steel mesh base.

3150 Broken tee caddy

SAND DISPENSER

Molded plastic bottles with powder coated steel holder. The sand dispenser features a unique spout designed to keep rain out and the mixture dry. The screw-on cap allows easy refilling mixture.

3142 Sand dispenser

31421 Steel holder

MESH RUBBISH BIN

The mesh design of these rubbish bins promotes air flow and circulation, reducing the possibility of bad odors, and allows maintenance staff to see at a distance which bins need to be emptied. The bins are tapered to hold litter securely in windy conditions. Size: 9 gallon (36 liter)

31311 Mesh rubbish bin- Green color



[3150]



[31421]

[3142]



[31311]



[3170]



[3175]



[3173]

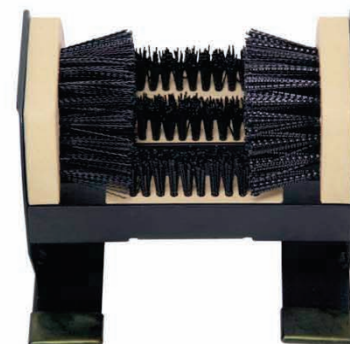

[3174]

SPIKE AND SHOE SCRUBBING MAT

Stiff nylon bristles held in stainless steel structure.
This mat allows you stand on it to clean your spikes and shoes effectively.
Size: 100cm*50cm
Color: green

Order information:
3175 Spike and Shoe Scrubbing Mat

STAND SHOE BRUSH

This unit comes with twin shoe cleaners for easy shoe cleaning. 32-1/4" (82cm) Tall. The stand and base are constructed with powder coated steel, and easily mounts to the ground with four mounting holes.

Order information:
3170 Stand shoe brush

SHOE CLEANER

Cleaning is both quick and effortless with 4 separate brushes.

Order information:
3173 Shoe cleaner

DELUXE SHOE CLEANER

Our new model shoe cleaner come from 31731. with two standing legs added, it can be free-standing or ground-mounted.

Order information:
3174 Deluxe Shoe Cleaner

DIMPLE TEE MARKER

Our conventional tee marker is 5 inches (12.7cm) in diameter and made from plastic with a stainless steel spike. Available in different colours.

Order information

- 3121A** Dimple Tee marker -Red
- 3121B** Dimple Tee marker -White
- 3121C** Dimple Tee marker -Blue
- 3121D** Dimple Tee marker -Yellow
- 3121E** Dimple Tee marker - Black

PERSONALIZED DIMPLE TEE MARKER

The same construction as the Dimple Tee marker but with additional beveled face to be personalized with your club logo.

Order information:

- 3122A** Personalized Dimple Tee marker -Red
- 3122B** Personalized Dimple Tee marker -White
- 3122C** Personalized Dimple Tee marker -Blue
- 3122D** Personalized Dimple Tee marker -Yellow
- 3122E** Personalized Dimple Tee marker -Black

DECALS FOR CUSTOM TEE MARKER

- 31221** Number Decals (Set of 18 pcs, 1-18)
- 31222** LOGO Decals (Set of 18 pcs)



[3122A]



[3121C]



[31222]





[3123C]



[3120A]



[3120P1]



[3120P2]

BALL TEE MARKERS

These 4-1/2" (11cm) Dia. Solid ball tee markers are made of durable resin and virtually unbreakable. With the shiny classic looking, they have no paint to chip or crack. Stainless steel spikes can be easy screwed in and out to convenient transportation.

Order information:

- 3123A** Ball tee marker -Red
- 3123B** Ball tee marker -White
- 3123C** Ball tee marker -Blue
- 3123D** Ball tee marker -Yellow
- 3123E** Ball tee marker -Black

BALL TEE MARKERS WITH NECK

Made of durable resin. Solid 5"(12.7cm) Dia. Ball plus a neck, unique neck keeps the marker at same height while minimizing grass burnout spots. Stainless steel spikes can be easy screwed in and out to convenient transportation.

Order information:

- 3120A** Ball tee marker with neck -Red
- 3120B** Ball tee marker with neck -White
- 3120C** Ball tee marker with neck -Blue
- 3120D** Ball tee marker with neck -Yellow
- 3120E** Ball tee marker with neck -Black

PERSONALIZED BALL TEE MARKERS

The same construction as ball tee marker with neck, but with additional beveled face to be personalized with your club logo.

Order information:

- 3120P1** Personalized ball tee marker with custom Decal
- 3120P2** Personalized ball tee marker -Moulded LOGO





[3126]

RECYCLED LOG TEE MARKER

Made from round 2(50mm) dia meter recycled plastic section with two steelspikes.

Order information:

- 3126A** Recycled log tee marker-Red
- 3126B** Recycled log tee marker-White
- 3126C** Recycled log tee marker - Blue
- 3126D** Recycled log tee marker - Yellow

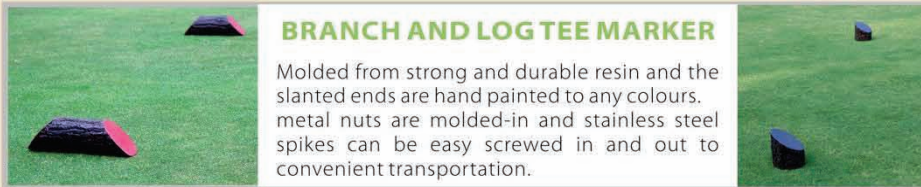

BRANCH AND LOG TEE MARKER

Molded from strong and durable resin and the slanted ends are hand painted to any colours. metal nuts are molded-in and stainless steel spikes can be easy screwed in and out to convenient transportation.

BRANCH TEE MARKER

Size: 3-1/3"DiaX10-3/5"
(Dia.84mm x 270mm) Weight: approx 1.1kg

Order information:

- 3124A** Branch tee marker -Red
- 3124B** Branch tee marker -White
- 3124C** Branch tee marker -Blue
- 3124D** Branch tee marker -Yellow
- 3124E** Branch tee marker -Black
- 3214_P** Personal Branch Tee Marker

LOG TEE MARKER

Size: 4"DiaX 4-1/4"(Dia.100mm x 108mm)
Weight: approx 0.7kg

Order information:

- 3125A** Log tee marker -Red
- 3125B** Log tee marker -White
- 3125C** Log tee marker -Blue
- 3125D** Log tee marker -Yellow
- 3125E** Log tee marker -Black
- 3125_P** Personal Log Tee Marker

BRANCH AND LOG TEE MARKER



[3125A]



[3125C]



[3124A]



[3124D]



Personalize Tee Marker with your LOGO

CUSTOM TEE MARKERS



CUSTOMIZED TEE MARKERS

To make your Tee Marker more attractive and personalized, you can design your own tee marker and let us make your design come true. For just a little more money, your golfer will love it.

Please see some samples of custom tee marker listed here. These attractive tee maker are molded from extremely strong and durable resin. Any custom shape can be produced from your supplied designs.

If you have a special design or tee marker concept in mind, we make it happen.

Order information:
312C Custom Tee Marker



CUSTOM TEE MARKER (CONT.)



09



10



11



12



13



14



15



16



17



18

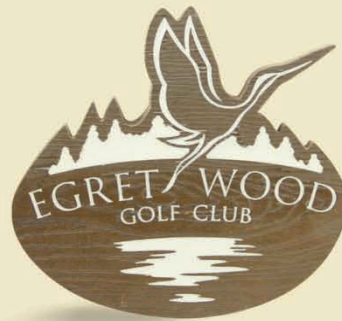

19



20



21

PLASTIC TEE MARKER

- Manufactured from solid plastic, maintenance free and fade resistance.
- LOGO can be either engraved in or created on vinyl and recessed down.
- LOGO can be on either single side or both sides.
- Welcome to discuss designing custom Tee Marker for your course.
- Primary color are : red, white, blue, yellow and black.



Order Information:

TM6RE1 6" Dia.Round, Engraved LOGO – Single Sided
TM6RE1D 6" Dia.Round, Engraved LOGO – Double Sided
TM6RO1 6" Dia.Round, Overlaid LOGO – Single Sided
TM6RO1D 6" Dia.Round, Overlaid LOGO – Double Sided

TTM6RE2 6" Dia.Round, Engraved LOGO – Single Sided
TM6RE2D 6" Dia.Round, Engraved LOGO – Double Sided
TM6RO2 6" Dia.Round, Overlaid LOGO – Single Sided
TM6RO2D 6" Dia.Round, Overlaid LOGO – Double Sided

TM6SE1 6" High Shield, Engraved LOGO – Single Sided
TM6SE1D 6" High Shield, Engraved LOGO – Double Sided

TM6SO1 6" High Shield, Overlaid LOGO – Single Sided
TM6SO1D 6" High Shield, Overlaid LOGO – Double Sided

TM9VE1 9" Wide Oval, Engraved LOGO – Single Sided
TM9VE1D 9" Wide Oval, Engraved LOGO – Double Sided
TM9VO1 9" Wide Oval, Overlaid LOGO – Single Sided
TM9VO1D 9" Wide Oval, Overlaid LOGO – Double Sided

TM8RE1 8" Dia. Round, Engraved LOGO – Single Sided
TM8RE1D 8" Dia. Round, Engraved LOGO – Double Sided
TM8RO1 8" Dia. Round, Overlay LOGO – Single Sided
TM8RO1D 5" Dia. Round, Overlay LOGO – Double Sided



6RE1
6" Dia.Round, Engraved LOGO



6RE2
6" Dia. Round, Engraved LOGO



6SE1
6" High Shield, Engraved LOGO



9VE1
9" Wide Oval, Engraved LOGO



8RO1
8.5" Dia. Round, Overlay LOGO



8RO1
8.5" Dia. Round, Overlay LOGO

PLASTIC TEE DECK SIGNS

- These signs are made from heavy-duty 2.5cm thick plastic.
- can be engraved with your yardage number, logo.
- Custom sizes are available upon request.

Order information:

36132 Plastic tee deck signs

COLORFUL PLASTIC TEE DECK MARKERS

- Made from durable colorful plastic, fade resistance.
- Engraved message and poured.
- Available colors: Red, White, Blue, yellow and Black.
- Size: 8"x 12"(20cm x 30cm), custom size are available upon request.

Order information:

3690 Colorful Tee Deck Yardage Markers

GRANITE TEE DECK SIGNS

- These signs are made from genuine granite, your message and design can be engraved on the polished surface and poured.
- Custom size or shape is available upon request.
- Color of granite: Black and grey.

Order information:

36131G Granite tee deck signs-Grey

36131B Granite tee deck signs-Black

SPRINKLER HEAD TAGS

- Customized tags for your sprinkler head. For just a little more money your golfer will love it.
- 1mm thick stainless tag or 3mm thick plastic tags fit into your sprinkler head well.
- Just send us your tag drawings and distance number, we will do all the rest for you.

Order information:

32751 Sprinkler Head Tag-Stainless Steel

32752 Sprinkler Head Tag-Plastic



[36132]



[3690]



[36131]



[3275]

CURVFORM RAKES

With its curved shape and short teeth, this rake effortlessly smooths sand back into perfect playing conditions. Made from sturdy plastic.

Head length: 15"(38cm)

Handle: Aluminium handle 54"(137cm),
or Aluminium handle 64"(163cm) bended,
or Fiberglass handle 54"(137cm).

Handle color: green
Handle color: green
Handle color: green

32111 Curvform rake head with **32101** handle

32112 Curvform rake head with **32102** handle

32113 Curvform rake head with **32105** handle

COMBTEETH RAKES

Sturdy solid plastic head feature long teeth.

Head Length: 14"(36cm)

Handle: Aluminium handle 54"(137cm),
or Fiberglass handle 54"(137cm).

Handle color: green

32121 Combteeth rake head with **32101** handle

32122 Combteeth rake head with **32102** handle

CART RAKES

Sturdy solid plastic head feature long teeth.

Head Length: 14"(36cm)

Handle: 44"(110cm)Aluminum handle without grip.
Handle color: green

32123 Combteeth rake head with **32106** handle

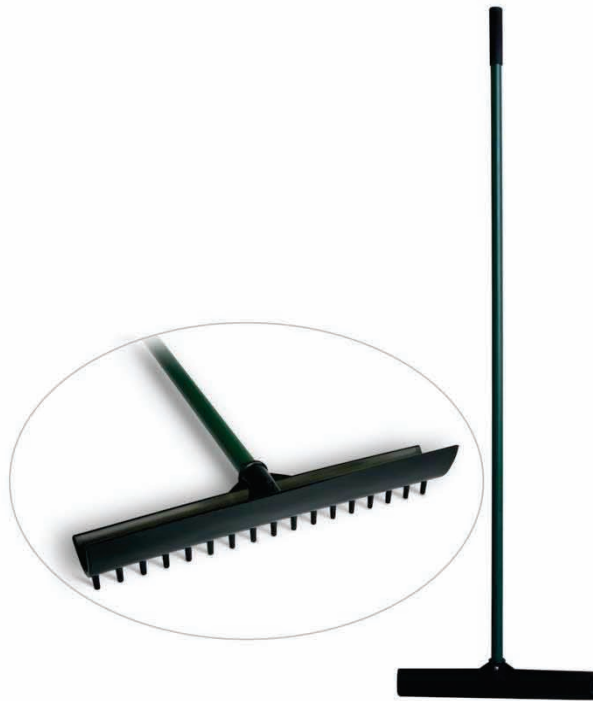

[32111]



[32122]



[32123]

HANDLES

PARSETT offers full size of aluminium and fiberglass handles for your selection.

1. The aluminium handles is powder coated, will not fade or chip.
2. The filament woven fiberglass handle is quite different from the normal pultruded fiberglass. They are lighter and never splinter.
3. Colour: green

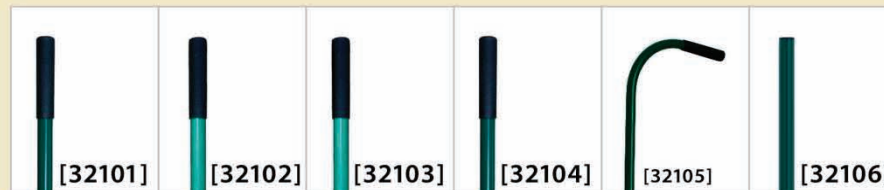

Order information:

32101 Aluminium handle with grip 54"(137cm)

32102 Fiberglass handle with grip 54"(137cm)

32103 Fiberglass handle with grip 72"(183cm)

32104 Aluminium handle with grip 96"(244cm)

32105 Bended aluminium handle with grip 64"(163cm)

32106 Aluminium handle without grip 44"(110cm)

TUBELIKE RAKE I

With its new design, ultra-lightweight and short teeth, this rake can greatly reduce furrows, leaving bunkers more consistent and smooth. Made from sturdy plastic.

Head Length: 17"(43cm)

Handles: Aluminium handle 54"(137 cm),
or fiberglass handle 54"(137 cm)
or aluminium bended handle 64"(163 cm),

Handle color: green

32181 Tubelike rake I head with **32101** handle

32182 Tubelike rake I head with **32102** handle

32183 Tubelike rake I head with **32105** handle

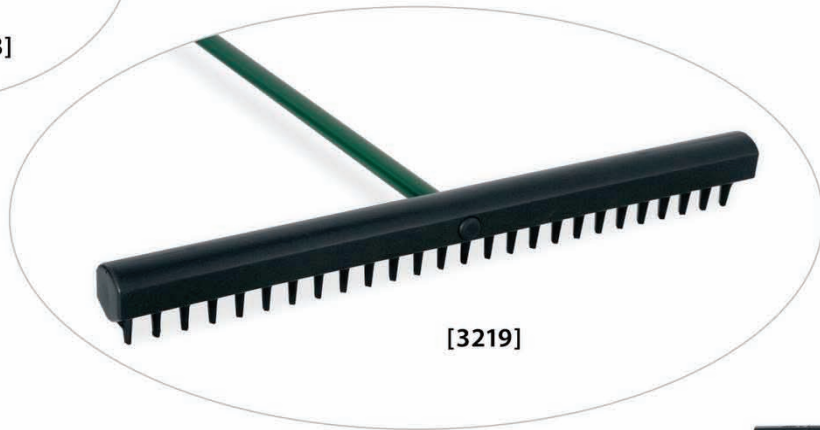

TUBELIKE RAKE II

The same construction as Tubelike Rake I.

Head Length: 25"(63cm)

Handles: Aluminium handle 54"(137 cm)
or fiberglass handle 54"(137 cm)
or fiberglass handle 72"(183cm)
or aluminium bended handle 64"(163cm)

Handle color: green

32191 Tubelike rake II head with **32101** handle

32192 Tubelike rake II head with **32102** handle

32193 Tubelike rake II head with **32103** handle

32194 Tubelike rake II head with **32105** handle



LONG HANDLE RAKE

96"(244cm) long handle, coupled with a 25"(63cm) tubelike Rake head II, is perfect for large, deep face bunker. Now, you can easily rake your bunker by standing on the edges of bunker.

Head Length: 25"(63cm)

Handle : Aluminium handle 96"(244cm)

Handle color: green

3220 Long handle rake

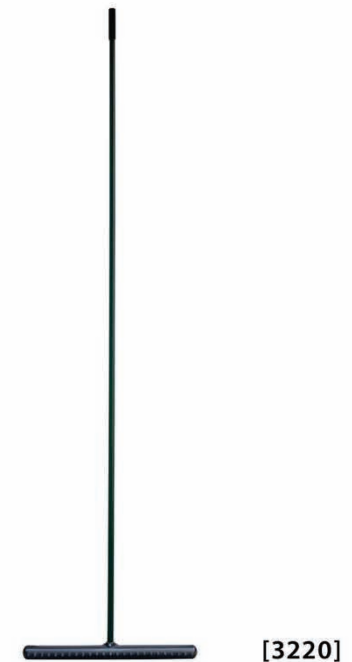

HANDLES

PARSETT offers full size of aluminium and fiberglass handles for your selection.

1. The aluminium handles is powder coated, will not fade or chip.
2. The filament woven fiberglass handle is quite different from the normal pultruded fiberglass. They are lighter and never splinter.
3. Colour: green

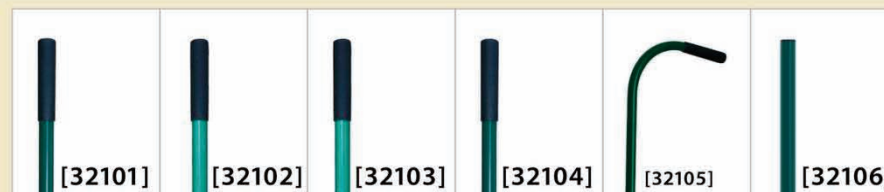

Order information:

- 32101** Aluminium handle with grip 54"(137cm)
- 32102** Fiberglass handle with grip 54"(137cm)
- 32103** Fiberglass handle with grip 72"(183cm)
- 32104** Aluminium handle with grip 96"(244cm)
- 32105** Bended aluminium handle with grip 64"(163cm)
- 32106** Aluminium handle without grip 44"(110cm)



[32671]



[32651]



[32672]



[32652]



[3233]



[3234]

ALUMINIUM FAIRWAY MARKERS

- 7-9/10"(20.0) cm diameter cast aluminium, powder coated with brushed aluminium number
- Completed with stainless steel spike.

Order information:

- | | |
|---|---|
| 32330 Aluminium fairway marker - 50 | 32331 Aluminium fairway marker - 100 |
| 32332 Aluminium fairway marker - 150 | 32333 Aluminium fairway marker - 200 |
| 32334 Aluminium fairway marker - 250 | |

GRANITE FAIRWAY MARKERS

- Made from genuine granite, yardage is engraved on the polished surface.
- Size: 8"x 12"(20cm x 30cm)

Order information:

- | | |
|-----------------------|-------------------------|
| 3234A Red-100 | 3234B White-150 |
| 3234C Blue-200 | 3234D Yellow-250 |

COLORFUL PLASTIC FAIRWAY YARDAGE MARKERS

- Made from durable colorful plastic, fade resistance.
- Engraved message and poured.
- Available colors: Red, White, Blue, yellow and Black.
- Choice of two sizes: 8" x 8" (20cm x 20cm) or 8" x 12" (20cm x 30cm)
- Custom size are available upon request.

Order Information:

Colorful Tee Deck Yardage Markers Size: 8" x 8" (20cm x 20cm)

- 32671A** Red (White Numbers)
- 32671B** White (Black Numbers)
- 32671C** Blue (White Numbers)
- 32671D** Yellow (Black Numbers)
- 32671E** Black (White Numbers)

Colorful Tee Deck Yardage Markers Size: 8" x 12" (20cm x 30cm)

- 32672A** Red (White Numbers)
- 32672B** White (Black Numbers)
- 32672C** Blue (White Numbers)
- 32672D** Yellow (Black Numbers)
- 32672E** Black (White Numbers)

PLASTIC YARDAGE MARKERS

- Durable plastic markers in two styles.
- Heavy-duty 2.5cm thick with Engraved numbers.
- Can be customized with your yardage number, logo.
- Stainless steel spikes included.

Order Information:

8" (20cm) Dia. round

- 32651A** Red (White Numbers)
- 32651B** White (Black Numbers)
- 32651C** Blue (White Numbers)
- 32651D** Yellow (Black Numbers)
- 32651E** Black (White Numbers)

8"x12" (20cm x 30cm) rectangular

- 32652A** Red (White Numbers)
- 32652B** White (Black Numbers)
- 32652C** Blue (White Numbers)
- 32652D** Yellow (Black Numbers)
- 32652E** Black (White Numbers)



[3235]



[3221]



[3222]

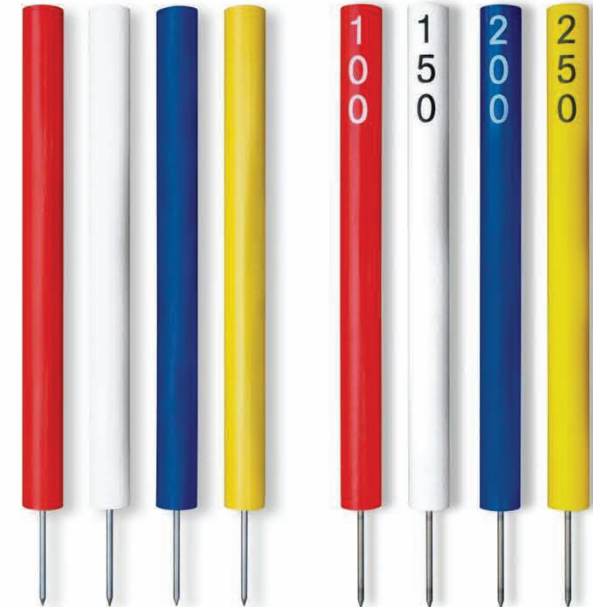

[3231]

[3232]

PVC YARDAGE MARKERS

- PVC tube with caps and spike. Colorful yardage number decals stuck on the top.
- They are highly visible, easy to remove and replace.
- Two different dimension of marker are available for your choice.

1-3/5" (4.0cm) dia. 24" (60cm) long

- 32210** White/green 50 Decal
- 32211** White/red 100 Decal
- 32212** White 150 decal
- 32213** White/blue 200 Decal
- 32214** White/Yellow 250 Decal

4" (10cm) dia. 32" (81cm) long

- 32351** White/green 50 Decal
- 32352** White/red 100 Decal
- 32353** White 150 decal
- 32354** White/blue 200 Decal
- 32355** White/Yellow 250 Decal

PLASTIC YARDAGE MARKERS

Molded with UV-resistant color, 2" (5.0cm) diameter, 24" (61cm) long plus stainless steel spike. Colourful yardage number decals stuck on the top. Highly visible and virtually unbreakable. Ideal for designating yardage to the green.

- 32221** White/red -100 yard
- 32222** White -150 yard
- 32223** White/blue -200yard
- 32224** White/Yellow -250yard

PLASTIC DISTANCE MARKER

Molded with UV-resistant colors, maintenance free, won't rot, crack.
 - 2" (5.0cm) diameter, 24" (61cm) long plus spike.
 - Yardage number can be engraved and poured.

- | | |
|---------------------------|------------------------------|
| 32311 Plain Red | 32321 Engraved Red |
| 32312 Plain White | 32322 Engraved White |
| 32313 Plain Blue | 32323 Engraved Blue |
| 32314 Plain Yellow | 32324 Engraved Yellow |



[3280]



[3236]



[3238]

ENGRAVED DISTANCE MARKER 1

- Recycle plastic 3-1/1" (9cm) square post with wood grain surface, 32" (81cm) long.
- Engraved and poured number on two sides of post.
- Two stainless steel spikes included for portable application.
- Custom markers are available upon request.

Order information:

- 32800** Marker-50
- 32801** Marker-100
- 32802** Marker-150
- 32803** Marker-200
- 32804** Marker-250

ENGRAVED DISTANCE MARKER 2

- Recycle plastic 3-1/7" (8cm) square post with semi-wood grain surface, 32" (81cm) long.
- Engraved and poured number on two sides of post.
- Two stainless steel spikes included for portable application.
- Custom markers are available upon request.

Order information:

- 32360** Marker-50
- 32361** Marker-100
- 32362** Marker-150
- 32363** Marker-200
- 32364** Marker-250

DUAL-TONE DISTANCE MARKER

- 2-2/5" (6cm) square recycled plastic Post, 32" (81cm) long plus stainless steel spike.
- 4" X11" (10cmx28cm) plastic face, engraved number.

Order information:

- 32381** 100-Red number
- 32382** 150-White number
- 32383** 200-Blue number
- 32384** 250-Yellow number



[3239]



[3240]

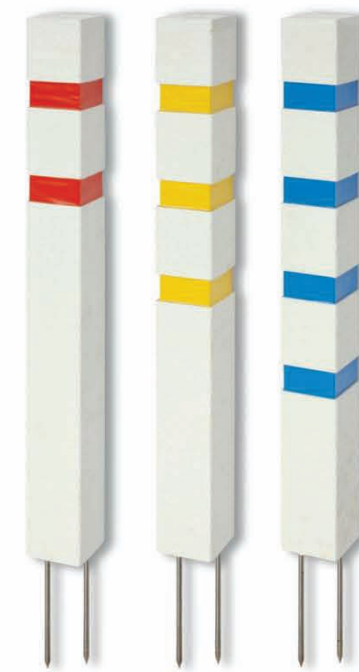

[3237]

DELUXE DISTANCE POST

- The markers are made from acrylic and mounted on the four side of square post. Utilizes reverse image graphics for weither durability.
- 3-1/2" (9cm) square plastic post with wooden grain surface ,32"(81 cm) long plus two stainless steel spikes.

Order information:

- 32391** Marker-100
- 32392** Marker-150
- 32393** Marker-200
- 32394** Marker-250

COLORFUL DISTANCE POST

- Recycled plastic 3.5"(9cm) square post, 32"(81cm) long.
- Engraved and poured numbers on two side of post.
- Two stainless steel spikes included for portable application.

Order information:

- 32401** Red marker with white number -100
- 32402** White marker with black number-150
- 32403** Blue marker with white number -200
- 32404** Yellow marker with black number -250

STRIPE DISTANCE MARKER

- Recycled plastic 3-1/7" (8cm) square post, 32" (81cm)long
- Two stainless steel spikes included for portable application.

Order information:

- 32371** One Stripe
- 32372** Two Stripes
- 32373** Three Stripes
- 32374** Four Stripes



NEW MATERIAL
Extruded of microcellular HDPE foam.

[3224]

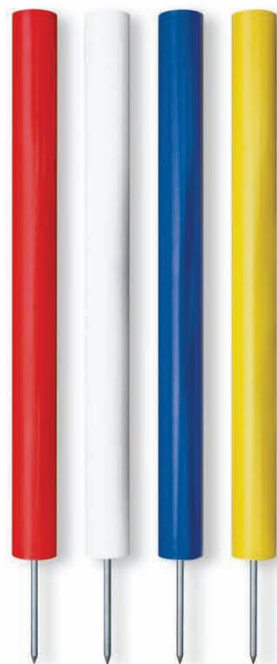

[3227]



NEW FEATURE
Pre-applied with Vinyl shrink-Wrap coverings

[3225]

SQUARE HAZARD MARKER

- Improved new material (extruded of microcellular HDPE foam)
- Colour-impregnated.
- 1-1/2"(3.8cm) square, 24"(61cm) long plus stainless steel spike.
- Fade resistant and float.
- Other size available upon request.

- 3224A** Square hazard marker - Red
- 3224B** Square hazard marker - Yellow
- 3224C** Square hazard marker - White
- 3224D** Square hazard marker - Blue

ROUND HAZARD MARKER

- Colour-impregnated recycled plastic (PVC)
- Fade resistant and float
- 2"(5.0cm) diameter, 24"(61cm) long plus stainless steel spike

- 3227A** Round hazard marker - Red
- 3227B** Round hazard marker - Yellow
- 3227C** Round hazard marker - White
- 3227D** Round hazard marker - Blue

PVC HAZARD MARKER

- These hazard markers come pre-applied with vinyl shrink-wrap covering to protect against fading, cracking, scratching and engineered for superior durability and visibility.
- 1-3/5"(4.0cm) diameter 24"(61cm) long with steel spike

- 3225A** PVC hazard marker - Red
- 3225B** PVC hazard marker - Yellow
- 3225C** PVC hazard marker - White



[3270]



[3228]



[3229] [3230]



[32291]

FAIRWAY MARKING POLE **NEW**

- 60"(152cm) long, 1-3/5"(4.0cm) diameter heavy-duty PVC pole pre-applied with vinyl-wrap covering for superior durability and visibility.
- Make to mark the center of the fairway, 150 yards, or other distances, or to indicate the edge of a hazard
- 10"(25cm), 2"(5.0cm) diameter ground anchor included.

- 32700** Black & White stripe
- 32701** Red and White stripe
- 32702** Black and Yellow stripe

ENVIRONMENTAL CAPS

- 4"(10.2cm) long vinyl cap to indicate environmental sensitive areas.
 - Fit in 1-1/2"(3.8cm) square post
 - Colour: green
- 3228** Environmental cap - green

DUAL-COLOUR MULTIPURPOSE MARKERS

- Durable multipurpose markers in two styles.
 - 1/2"(3.8cm) square recycled plastic white stakes with 4"(10cm) green vinyl cap and sleeve.
 - stainless steel spike included.
 - These useful markers allow you to designate the desired usage in the way you like: To direct cart and foot traffic, to protect wet and new soil areas, or to circle a specific area on the ground
- 3229** 2-Stripes Multipurpose Marks
 - 3230** 4-Stripes Multipurpose Marks, 18" (46cm) long, 4 stripes
 - 32291** 2-Stripes Multipurpose Marks in bucket (25pcs)

SQUARE ROPE STAKE

- 1-1/2"(3.8cm) square recycled plastic
- Slot designed for 1/4"(0.64cm) braided rope.
- Complete with stainless steel spike.
- Colour: green



[3243]

Order information:

- 32411** 12"(30.5cm) long
- 32412** 18"(45.7cm) long
- 32413** 24"(61cm) long

STEEL ROPE STAKE

- Total 38-3/5"(98cm) long.
- 1/4"(0.65cm) in diameter
- Galvanized finish
- Positions easily with foot pressure

Order information:

- 3242** Steel rope stake

POLYTHENE BRAIDED ROPE

- 1/4"(0.65cm) diameter
- Each coil contains 1000ft(305m)
- Available in 4 colours

Order information:

- 3243A** - Yellow
- 3243B** - White/green
- 3243C** - White
- 3243D** - Green

SAFETY NET

- 6.5x6.5"(2m x 2m) heavy-duty polyethylene net with yellow border.
- Two aluminium poles with stakes keep the net upright.
- Collapsible frame design, so it is easy to pack everything in one package.
- Two stakes included to keep the net upright.

Order information:

- 3279** Safety Net



[3279]

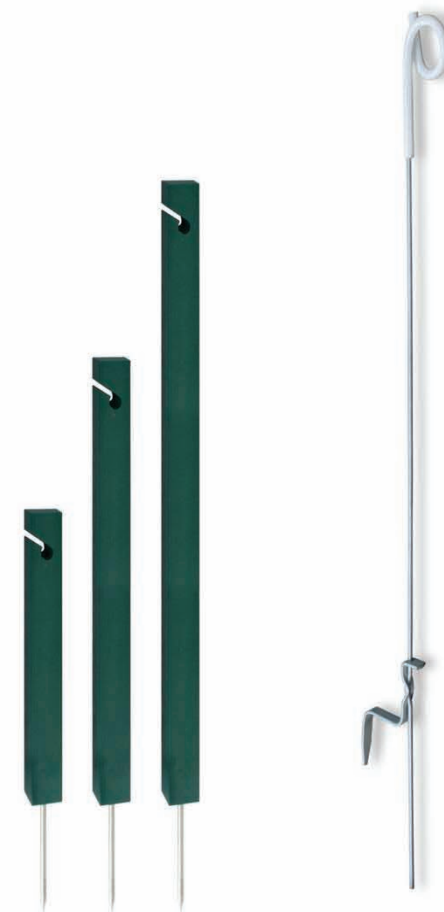

[3241]

[3242]

FLAGS

We make and supply superior quality golf flags, crafted of 420 Denier high quality nylon material.

- All our flags are made by our in house professional flag makers with stronger stitching, including bar-tracked corners, double rows and zig-zag stitched or triple stitching on the fly hem, ensures durability in extreme wind conditions.
- Improved fade resistant colour to extend the life of a golf flag.
- Available in convenient tube-style and tie-style.
- Size(approx): 20"X13-1/2"(51cmX34cm)

Colors in stock:



A-Red



B-Yellow



C-Blue



D-White



E-Gold



F-Black



G-Hunter green



H-Pink

Grommet-tie Flags

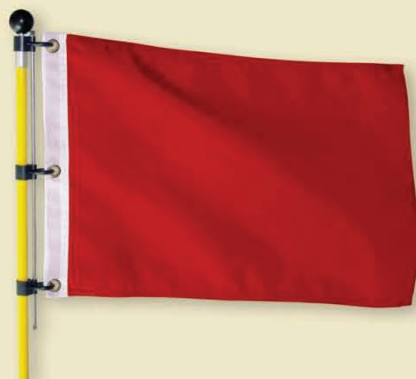

Tie style flags require swivels and ties for attachment to the flagstick.

Tube lock Flags



The flags are sewn to a molded one-piece plastic tube, simply slip over the flagstick

SOLID FLAGS



[3320]

NUMBERED FLAGS



[3321]

Order information

- **Solid Red**
3320A1 Tube-lock
3320A2 Grommet-tie
- **Solid White**
3320D1 Tube-lock
3320D2 Grommet-tie
- **Solid Green**
3320G1 Tube-lock
3320G2 Grommet-tie

- **Solid Yellow**
3320B1 Tube-lock
3320B2 Grommet-tie
- **Solid Gold**
3320E1 Tube-lock
3320E2 Grommet-tie
- **Solid Pink**
3320H1 Tube-lock
3320H2 Grommet-tie

- **Solid Blue**
3320C1 Tube-lock
3320C2 Grommet-tie
- **Solid Black**
3320F1 Tube-lock
3320F2 Grommet-tie

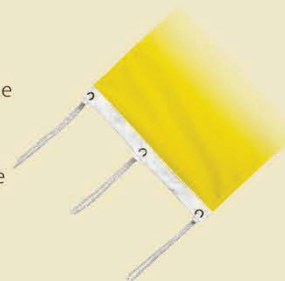

Order information

- **Red with white number**
3321A1 Tube-lock 1-9
3321A2 Tube-lock 10-18
3321A3 Grommet-tie 1-9
3321A4 Grommet-tie 10-18
- **Blue with white number**
3321C1 Tube-lock 1-9
3321C2 Tube-lock 10-18
3321C3 Grommet-tie 1-9
3321C4 Grommet-tie 10-18

- **Yellow with black number**
3321B1 Tube-lock 1-9
3321B2 Tube-lock 10-18
3321B3 Grommet-tie 1-9
3321B4 Grommet-tie 10-18
- **White with red number**
3321D1 Tube-lock 1-9
3321D2 Tube-lock 10-18
3321D3 Grommet-tie 1-9
3321D4 Grommet-tie 10-18

TWO-TONE FLAGS



[3322]

BORDERED FLAGS



[3323]

Order information

- 3322AG** Red with hunter green tube
- 3322BF** Yellow with black tube
- 3322CF** Blue with black tube
- 3322DC** White with blue tube
- 3322AF** Red with black tube
- 3322BG** Yellow with hunter green tube
- 3322DG** White with hunter green tube
- 3322DA** White with red tube

White with black border **3323DF**

Order information

- 3323AG** Red with hunter green border
- 3323BF** Yellow with black border
- 3323BG** Yellow with hunter green border
- 3323DC** White with blue border
- 3323AF** Red with black border
- 3323CF** Blue with black border
- 3323DG** White with hunter green border
- 3323DA** White with red border

CHECKERED FLAGS



[3324]

CUSTOM FLAGS

1. SCREEN PRINTED FLAGS



2. EMBROIDERED FLAGS



Red & White

3324A1 Tube-lock
3324A2 Grommet-tie

Golden & Black

3324B1 Tube-lock
3324B2 Grommet-tie

Blue & White

3324C1 Tube-lock
3324C2 Grommet-tie

Black & Yellow

3324D1 Tube-lock
3324D2 Grommet-tie

Black & White

3324E1 Tube-lock
3324E2 Grommet-tie

Green & White

3324F1 Tube-lock
3324F2 Grommet-tie

PINK & White

3324G1 Tube-lock
3324G2 Grommet-tie

All our regulation flags can be customized with your logo or message. It can be either screen printed or embroidered, all you have to do is provided us with high quality artwork and our skillful staff will do the rest.

PLACEMENT FLAGS

These flags are used to indicated different hole locations on the green. For example a yellow flag may indicate that the hole location is at the front of a green, while a red flag may indicate the center of a green. These flags can also be screen printed with a message. For example "Please repair pitch marks, thank you".

Material: high quality Nylon
Size: 5"X7-1/2"(13cmX19cm)

Order information

- 3328A1** Plain Red
- 3328A2** Red flag white printing
- 3328B1** Plain Yellow
- 3328B2** Yellow flag black printing
- 3328C1** Plain Blue
- 3328C2** Blue flag white printing

PLACEMENT MARKERS

Resilient Plastic material. Dia. 3-3/5"(92mm).
Fits 1/2"(12.7mm) flagstick only.

Order information:

- 3329A** Red
- 3329B** Yellow
- 3329C** Blue
- 3329D** White

RUBBER GROMMET

The rubber grommet can be used to hold the hole location indicator positioned on the flagstick.

Order information:

- 33291** Fits 1/2"Dia.(13mm) Flagstick
- 33292** Fits 3/4"Dia.(19mm) Flagstick

FLAG TUBE

18mm inside diameter, strong and durable material.

Order information:

- 33271** Flag tube



[3328]

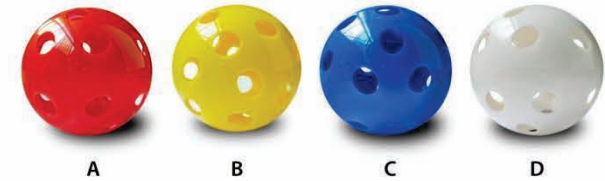

[3329]



[33291]







[33292]



[33271]

FLAGSTICK PARTS.

1. TOP STUDS

 <ul style="list-style-type: none"> - Aluminum - Anodized Nature - Aluminium Acorn Nut - Thread Size: M8 <p>[3315C1]</p>	 <ul style="list-style-type: none"> - Aluminum - Anodized Black - Plastic Acorn Nut - Thread Size: M8 <p>[3315C2]</p>	 <ul style="list-style-type: none"> - Aluminum - Anodized Black - Plastic Ball Nut 25mmDia. - Thread Size: M8 <p>[3315C3]</p>
 <ul style="list-style-type: none"> - Aluminum - Anodized Black - Plastic Ball Nut 30mmDia. - Thread Size: M8 <p>[3315C4]</p>	 <ul style="list-style-type: none"> - Aluminum - Anodized Black - Plastic Ball Nut 41mmDia. - Thread Size: M8 <p>[3315C5]</p>	 <ul style="list-style-type: none"> - Aluminum - Anodized Black - Plastic Acorn Nut - Thread Size: 3/8"-24 <p>[3315C6]</p>

2. FERRULES

 <ul style="list-style-type: none"> - Cost Aluminum - 27mm Dia <p>[3315A]</p>	 <ul style="list-style-type: none"> - Aluminum - 19mm Dia - Anodized Black <p>[3315B1]</p>	 <ul style="list-style-type: none"> - Aluminum - 19mm Dia - Anodized Nature <p>[3315B2]</p>
---	---	--

3. SWIVEL



Material: stainless steel rod and plastic clips.

[33272]

FLAGSTICKS

PARSETT make and supply three kinds of flagsticks, they are:

- 1/2" (12.7mm) Regular flagsticks
- 3/4" (19mm) Tournament flagsticks
- 1" (25mm) Tournament flagsticks

They are all made of solid colour-impregnated fiberglass designed to prevent fading and chipping.

All our flagstick come complete with ferrule and top stud, and we have series of flagstick parts with different features to meet your requirements and convention. Please let us know which ferrule or top stud you would like to use when ordering our flagsticks. Also custom flagstick parts is available upon your request.



1.SOLID COLOUR REGULAR

2.STRIPED REGULAR

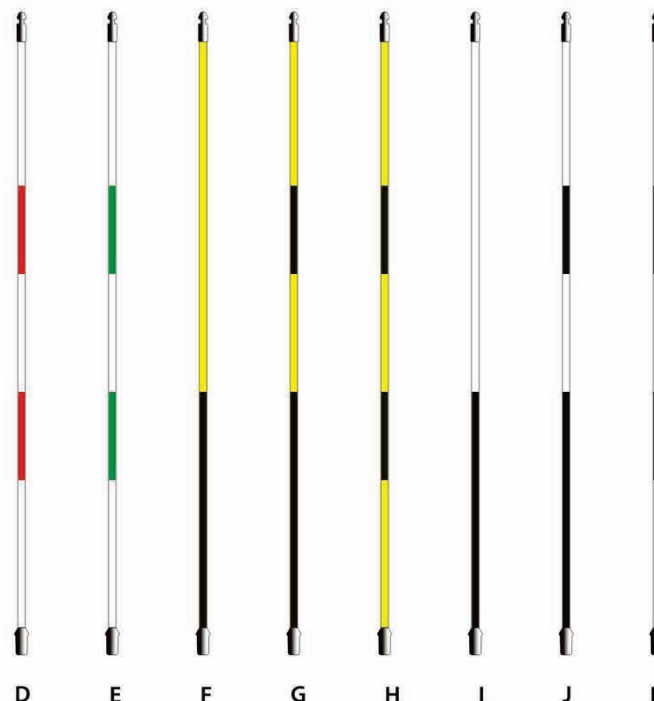
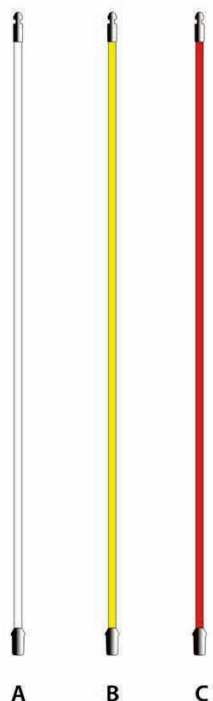

1.SOLID COLOUR REGULAR

Fiberglass flagsticks, 1/2" (12.7mm) Dia, Colour impregnated

SOLID BRIGHT WHITE (A-TYPE)	SOLID BRIGHT YELLOW (B-TYPE)	SOLID BRIGHT RED (C-TYPE)
3311 A0 6'Tall	3311 B0 6'Tall	3311 C0 6'Tall
3311 A1 7'Tall	3311 B1 7'Tall	3311 C1 7'Tall
3311 A2 7.5'Tall	3311 B2 7.5'Tall	3311 C2 7.5'Tall
3311 A3 8'Tall	3311 B3 8'Tall	3311 C3 8'Tall
3311 A4 10'Tall	3311 B4 10'Tall	3311 C4 10'Tall

2.STRIPED REGULAR

Fiberglass flagsticks, 1/2" (12.7mm) Dia, Multitude of colour and style combination.

WHITE/RED STRIPE (D-TYPE)	WHITE/GREEN STRIPE (E-TYPE)	YELLOW/30" BLACK BOTTOM (F-TYPE)	YELLOW/BLACK BRITISH STRIPE (G-TYPE)
3311 D1 7'Tall	3311 E1 7'Tall	3311 F1 7'Tall	3311 G1 7'Tall
3311 D2 7.5'Tall	3311 E2 7.5'Tall	3311 F2 7.5'Tall	3311 G2 7.5'Tall
3311 D3 8'Tall	3311 E3 8'Tall	3311 F3 8'Tall	3311 G3 8'Tall
YELLOW/BLACK STRIPE (H-TYPE)	WHITE/30" BLACK BOTTOM (I-TYPE)	WHITE/BLACK BRITISH STRIPE (J-TYPE)	WHITE/BLACK STRIPE (K-TYPE)
3311 H1 7'Tall	3311 I1 7'Tall	3311 J1 7'Tall	3311 K1 7'Tall
3311 H2 7.5'Tall	3311 I2 7.5'Tall	3311 J2 7.5'Tall	3311 K2 7.5'Tall
3311 H3 8'Tall	3311 I3 8'Tall	3311 J3 8'Tall	3311 K3 8'Tall



[3313]

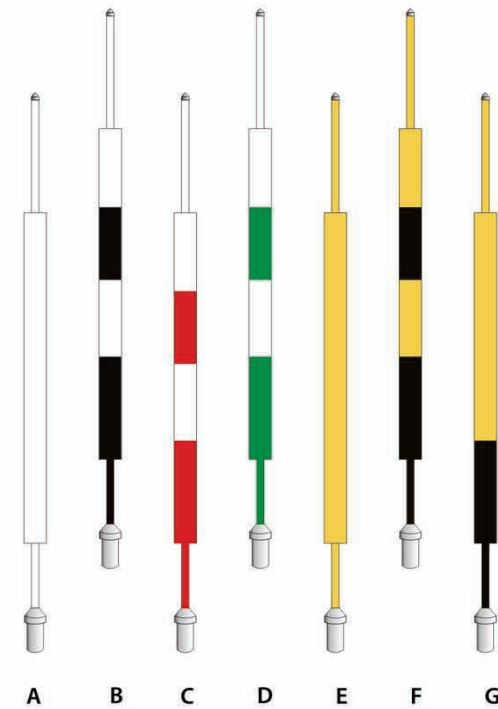

[3314]

TOURNAMENT FLAGSTICKS

Javelin style flagsticks feature extra thickness in the center for increased strength, visibility and wind resistance.
 Size: 1/2" (12.7mm) diameter at the top and bottom, 3/4" (19mm) diameter at the center.

Order information:

- 3313A** 7.5' Solid White
- 3313B** 7.5' White/red British stripe
- 3313C** 7.5' White/black British stripe
- 3313D** 7.5' White/green British stripe

- 3313E** 7.5' White/30" Black bottom
- 3313F** 7.5' Solid Yellow
- 3313G** 7.5' Yellow/black British stripe
- 3313H** 7.5' Yellow/30" Black bottom

TOURNAMENT FLAGSTICKS

Standing tall and proud at 8' high, these tournament flagsticks feature an extra thick center section for increased strength, visibility and wind resistance.
 Size: 1/2" (12.7mm) diameter at the top and bottom, 1" (25mm) diameter at the center.

Order information:

- 3314A** 8' Solid White
- 3314B** 8' White/black British stripe
- 3314C** 8' White/red British stripe
- 3314D** 8' White/green British stripe

- 3314E** 8' Solid Yellow
- 3314F** 8' Yellow/black British stripe
- 3314G** 8' Yellow/30" black bottom

VINYL-WRAPPED FLAGSTICKS

These flagsticks come pre-applied with vinyl shrink-wrap coverings to have a better surface protection. No painting at all and available in different colors and striping patterns. Both 1/2" and 3/4" Dia. flagsticks are available to supply.

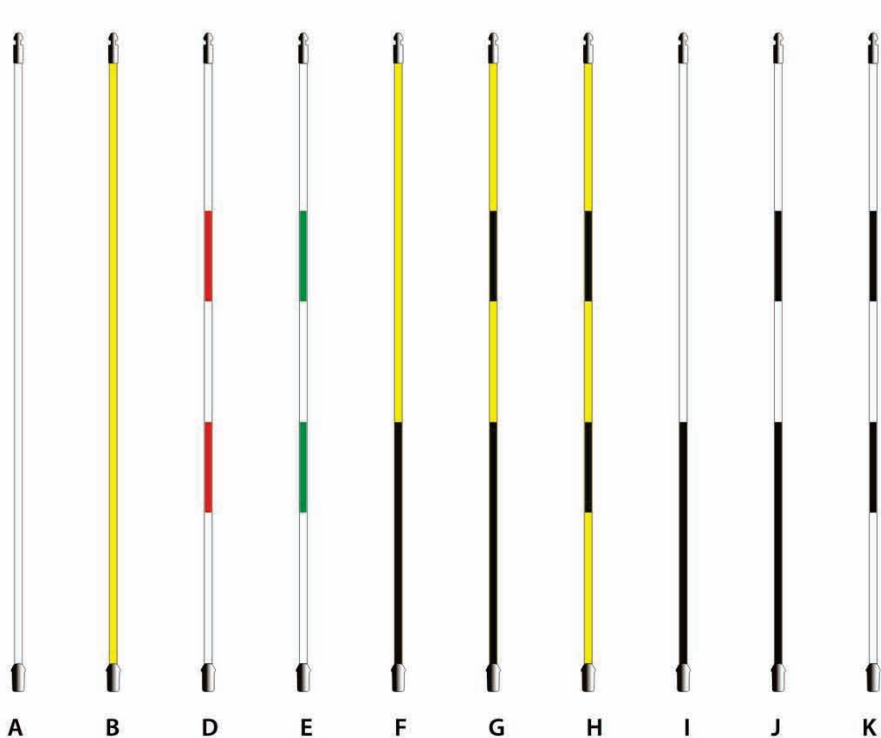

[3311V]

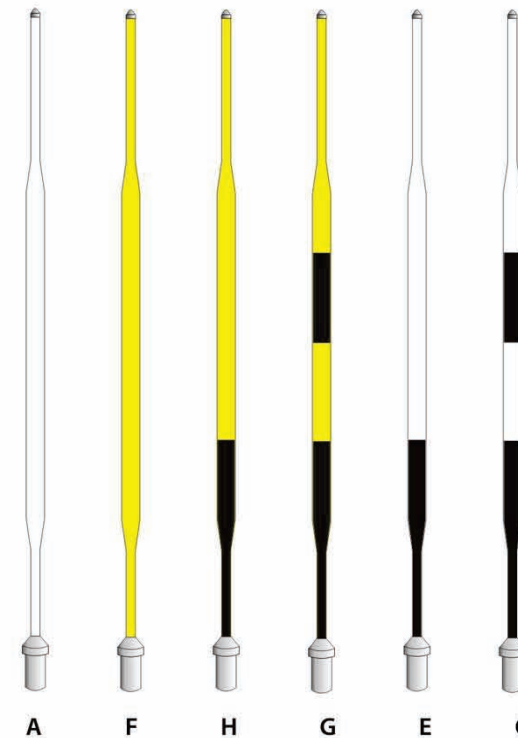

[3313V]

VINYIWRAPPED 1/2" REGULAR FLAGSTICKS

BRIGHT WHITE (A)	BRIGHT YELLOW (B)	WHITE & RED (D)	WHITE & GREEN (E)	YELLOW & BLACK (F)
3311VA1 7'Tall	3311VB1 7'Tall	3311VD1 7'Tall	3311VE1 7'Tall	3311VF1 7'Tall
3311VA3 8'Tall	3311VB3 8'Tall	3311VD3 8'Tall	3311VE3 8'Tall	3311VF3 8'Tall
YELLOW & BLACK (G)	YELLOW & BLACK (H)	WHITE & BLACK (I)	WHITE & BLACK (J)	WHITE & BLACK (K)
3311VG1 7'Tall	3311VH1 7'Tall	3311VI1 7'Tall	3311VJ1 7'Tall	3311VK1 7'Tall
3311VG3 8'Tall	3311VH3 8'Tall	3311VI3 8'Tall	3311VJ3 8'Tall	3311VK3 8'Tall

VINYL WRAPPED 3/4" TOURNAMENT FLAGSTICKS

BRIGHT WHITE (A)	BRIGHT YELLOW (F)	YELLOW & BLACK (H)
3313VA 7.5'Tall	3313VF 7.5'Tall	3313VH 7.5'Tall
YELLOW & BLACK (G)	WHITE & BLACK (E)	WHITE & BLACK (C)
3313VG 7.5'Tall	3313VE 7.5'Tall	3313VC 7.5'Tall

PRISM FLAGSTICKS

- For use with all distance rangefinders to give precise reading.
- Reflecting prisms are built directly into the body of the flagsticks, make it the most discreet reflector option we offer.
- Prism flagsticks are available in 1/2 inch and 3/4 inch tapered shafts.
- Colors not included above are available upon request



[3315]

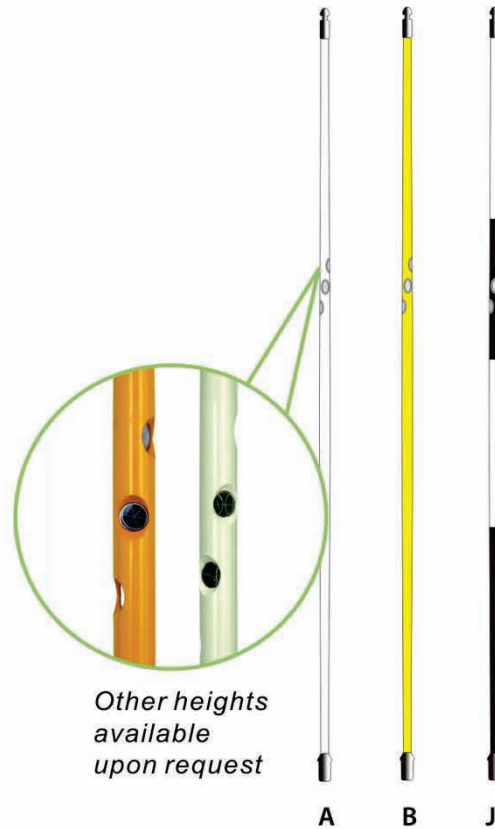

Other heights available upon request

A B J

[3311R]

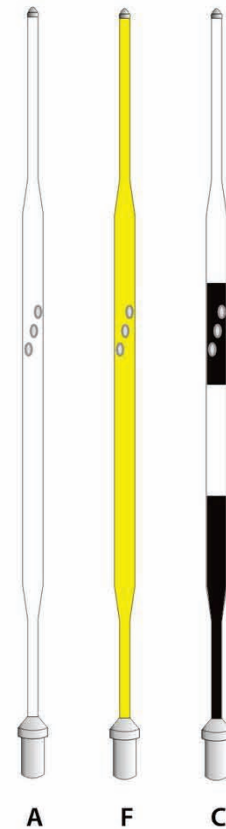

A F C

[3313R]

AimPin REFLECTORS

- Screws directly on the top of existing flagsticks in place of acorn nut with 3/8"-24 threaded or M8 threaded tips.
- Features Nylon threads, no brass insert prevents seizing to the top of the flagsticks.
- New six-prisms pod design, 100% reflection coverage, leaving no dead spots.

3315E AimPin Reflector with Thread size:3/8"-24

3315M AimPin Reflector with Thread size: M8

TOUR PRISM FLAGSTICKS

1/2" solid fiberglass

Order Information:

3311RA1 Bright White 7' tall

3311RA3 Bright White 8' tall

3311RB1 Bright Yellow 7' tall

3311RB3 Bright Yellow 8' tall

3311RJ1 White/Black British Stripe 7' tall

3311RJ3 White/Black British Stripe 8' tall

TOURNAMENT PRISM FLAGSTICKS

3/4" solid fiberglass

Order Information:

3313RA Bright White 7.5' tall

3313RF Bright Yellow 7.5' tall

3313RC White/Black British Stripe 7.5' tall

LASER LINK RANGEFINDERS

Parsett is proud to be the exclusive distributor for Laser Link Golf in Greater China Region, including Mainland China, Hongkong, Marco and Taiwan, will be responsible for introducing the Laser Link Distance System to the golf courses in the Territory.

Laser Link Golf is the producer of the Laser link Distance System, the revolutionary distance measurement system designed specifically for golf. The laser-based system Utilizes two components - a handled laser rangefinder and a flagstick-based reflector- to determine the exact distance to the flagstick. Laser Link Golf products include the popular QuickShot rangefinder, the Red Hot rangefinder , the Switch rangefinder, the Smartstick reflector system, and the Smarty flagstick reflector. The System is designed to speed up play and add enjoyment to the game.

For more information about Laser Link Golf, please contact us or visit www.laserlinkgolf.com

Order information:

- 9909** Red Hot Rangefinder
- 9689** Quickshot Rangefinder
- LLS-1200** Switch Rangefinder

have always believed that having information, and more important, accurate information on yardages helps improve not only your performance but the overall golf experience. The Laser Link Distance System is the best way to find distance measurements quickly and accurately. Whether it is to help your performance or the speed of play, having this information on the course, literally at your fingertips, is a benefit for those that enjoy the game of golf.

Jack Nicklaus



When you want the best information, who do you ask?

You ask someone who can give you the information you need quickly, accurately, and simply. Ideally you want an expert? someone with the ultimate knowledge on the topic at hand. Without question, Jack Nicklaus has proven himself as the ultimate expert when it comes to the game of golf. His playing record as both an amateur and a professional has earned him the title as the best to ever play the game. And when the best wants to know the distance, the expert he trusts is the Laser Link Distance System.



[9689]



[9909]



[LLS-1200]



[3300]



CUP BOTTOM PATTERN



[3348]



[3348P]



[3333]



[3331]

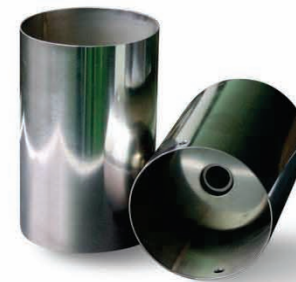

[3330]

ALUMINIUM GREEN CUP

- It's die cast in precision dimensions, 6 support pads on the bottom of the cup that eliminate sinking to maintain a stable height.
- Surface anodized and vertical surfaces are powder coated bright white.
- Size: 6"HX4-1/4"Dia. (15cm X 10.8cmDia.)

Order information:

- 3348** Aluminum Green Cup (Fit ferrule size:27mm)
- 3348P** Aluminum Green Cup-Pink (Fit ferrule size:27mm)

EZ-WHITE CUP

- Ensure your holes remain perfectly white forever with our EZ-White Cup.
- Easily replaceable bright liner stays tight in the cup.
- The liner can easily be changed on a weekly basis or for special events.
- Your name or logo can also be added for your corporate events.
- Surfaces Anodized black aluminium cup plus bright white plastic liner, No paint to chip.

Order information:

- 3300** EZ-White Cup (Fit ferrule size:27mm)
- 3301** EZ-White Cup Replacement Liner

STAINLESS STEEL GREEN CUP

These cups are made from stainless steel material, can be rust resistant and virtually unbreakable.
Size: 6"HX4-1/4"Dia.(15cm X 10.8cmDia)

Order information:

- 33301** Stainless steel cup (Fit ferrule size: 27mm)
- 33302** Stainless steel cup (Fit ferrule size: 19mm)

COPPER BELL GREEN CUP

This cup has a copper bell inside the cup giving a pleasing sound as the golf ball drops into the hole.
Size: 6-7/10"HX4-1/4"Dia.(17cm X 10.8cmDia.)

Order information:

- 3331** Copper Bell green cup (Fit ferrule size: 19mm)

PLASTIC PUTTING CUP

This cup is with a brilliant white colour, made of strong plastic for chemical resistance, featuring taper to allow easy removal from the hole.
Size: 6"HX4-1/4"Dia.(15cm X 10.8cmDia.)

Order information:

- 3333** Putting Cup (fit ferrule size:27mm)

ALUMINUM CUP SETTER

Heavy duty cast aluminum design, powder coated green. Used to seats cup to correct depth and flattens down cup hole edges.

Order information:

3334 Aluminum cup setter



[3334]

STEEL FIXTURE

This device is used to accurately paint the area above the green cups.

Order information:

3335 Steel fixture



[3335]

RUBBER CUP REDUCER

Made of recycled crumb rubber. Reduced the hole size from 4- 1/4" to 3-1/4"(10.83cm to 8.3cm) by resting the cup reducer on the top of regular size cup. It's a perfect choice for you to improve putting skills or for special events.

Size: 4 1/4" Dia.X1"H(10.6cmDia X 2.5cmH)

Order information:

3338 Rubber cup reducer



[3338]

RUBBER CUP COVER

Used for low play period or when top dressing. It's made of recycled crumb rubber, fit any regulation cup and will not damage mowers.

Size: 4 1/4" Dia.X1"H(10.6cmDia X 2.5cmH)

Order information:

3339 Rubber Cup Cover



[3339]

CUP PULLERS

Three-hook cup puller: Made of stainless steel, pulls cup out of hole straight, easy pull with no damage to the turf.

Two -hook cup puller: Made of stainless steel. Pulls cup out from ferrule hole.

Order information:

33371 Three-hook cup puller

33372 Two-hook cup puller



[33372]



[33371]



[3336]

TARGET RING

Made of plastic. Bright white colour to highlight area above cup.

Order information:

3336 Target Ring



[3380]

i-Plus HOLE CUTTER

- Impact-Plus, Hammer action Hole Cutter consisted of a traditional lever Action Hole Cutter and a Special Hammer.
- The Hammer can be easily separated from the hole cutter and the hammer weight can be adjusted as per your needs.
- It's quite simple and easy to operate, simply pull out the pin, lift the handle, and hammer action drives it into the ground.
- Two blade types available :

Outside sharpened blade: for heavier soil green
Inside sharpened blade: for lighter soil green

ADVANTAGES:

- Perfectly round holes with clean edges.
- Reduces arm/shoulder fatigue.
- Back-saving, eliminate awkward twisting action.
- Less cutting time.
- The hammer can be easily separated from hole cutter to reduce the cutter's weight.
- The hammer's weight can be adjusted according to your green soil conditions.

Order information:

- 33801** i-Plus Hole Cutter with Inside Sharpened Blade
- 33802** i-Plus Hole Cutter with Outside Sharpened Blade



PATENT PENDING

HOLE CUTTER

Made chiefly of steel alloy and aluminium alloy for light weight and strength. Heat treated hardened steel blades are also dip-treated for corrosion resistance.

Order information:

- 33411** Lever Action Hole Cutter with Scalloped blade, inside edge.
- 33412** Lever Action Hole Cutter with Scalloped blade, outside edge.
- 33413** Lever Action Hole Cutter with Straight blade, inside edge.

- 33421** Foot Action Hole Cutter with Scalloped blade, inside edge.
- 33422** Foot Action Hole Cutter with Scalloped blade, outside edge.
- 33423** Foot Action Hole Cutter with Straight blade, inside edge.

HOLE CUTTER BLADES

Heat treated hardened steel blade. Scalloped or straight blade for your choice.
 Size:10.8cm
 Weight:1.1kg

Order information:

- 33431** Scalloped blade, inside edge
- 33432** Scalloped blade, outside edge
- 33433** Straight blade, inside edge
- 33434** Straight blade, outside edge

HOLE CUTTER SHARPENER

For clean, sharp hole edges in your green, please give your hole cutter blade a few passes everyday with this handy tool to keep scalloped or straight cutter blade sharp. Easy to use and very economical.

Order information:

- 3347** Hole Cutter Sharpener

DEPTH GAUGE

This gauge ensures consistent hole depth every time and attaches to our hole cutters.

Order information:

- 3344** Depth Gauge

CUTTER GUIDE

Made of strongest plastic, 15mm thick. Place the guide on the green and stand with both feet on the guide when cutting holes to eliminate heel marks and raised hole edges.

Order information:

- 3345** Cutter Guide



[3347]



[3344]



[3341]

[3342]



[33431]

[33433]



[3345]



[3245]



[3258]



[3250]



[3259]

MEASURING WHEEL

This handy device allows the accurate measurement of distance across all types of surfaces. Counter reads up to 10,000 meters. It is made of precision steel with a folded handle grip and a plastic measuring wheel.

Order information:

3245 Measuring Wheel

DEW-WHIPPER

Two piece design, aluminium handle and fiberglass extension rod.

Handle length: 7-7/8" (240cm)

Extended length: 15-3/5" (475cm)

Order information:

3258 Dew-Whipper

GREEN SPEEDMETER

This device is designed for measuring speed of putting surface. Made of aluminium alloy and have good finish. (Instruction included)

Order information:

3250 Green Speedmeter

FOLDABLE DEW BRUSH

Designed for fast removal of dew from green. Total 10ft (300cm) width nylon brush in two halves fixed in strong aluminium bracing bracket. Aluminium handle in 72" (183cm) long.

Easy folding and light weight.

Order information:

3259 Foldable Dew Brush



[3252]



[32512]



[32511]

TURF REPAIRER

This turf repairer can be used to cut hexagonal plugs of turf for easy removal and replacement.

Order information:
3252 Turf Repairer

THREE TINES HAND OPERATED AERATOR

If the ground is too hard for seven tines to penetrate, there is provision for three to be used at 100mm spacing. Tine size: 2/5" Dia. X 4-3/5" (1cm Dia. X 120mm)

Order information:
32512 Three Tines Hand Operated Aerator

SEVEN TINES HAND OPERATED AERATOR

This aerator can be easily used to aerate small areas where compaction may have occurred or for aiding water percolation. Seven hollow or solid tines at 50mm spacing. A core collection is included. Tine size: 3/8" Dia. X 3" (0.95cm Dia. X 76mm)

Order information:
32511H Seven Hollow Tines Hand Operated Aerator
32511S Seven Solid Tines Hand Operated Aerator



[3256]



[3249]



[3257]

TURF PLUGGER

Ideal for replacing worn, damaged areas with healthy turf. Tube handle can hold up the plugs thus eliminating the need for clean up. Simply replace damaged plug with healthy plug from the top of the tube. 31-1/2"(80cm) tall Stainless Steel tube. Replaceable cutter blade made from case hardened steel. Plug measures: 2-1/6"(55mm) Dia X 2-3/5"(66mm) deep.

Order information:
3256 Turf Plugger

SOIL SAMPLER

This unique designed soil sampler allows you to sample root growth beneath the surface. It is made from stainless steel pipe with a rubber grip. Size: 7/8"(22mm) Dia. X 19-5/8"(50cm) Length

Order information:
3249 Soil Sampler

SOIL PROFILE SAMPLER

Slicing a sample 6" long by 3" wide and 3/5" thick, this tool's jaws are hinged at the top for easy opening and inspection. Sample can be easily redeposited by keeping one side open and replacing in hole.

Order information:
3257 Soil profile sampler



DRAG BRUSH

Gently and evenly spreads dressing material over the green and also helps control thatch when used before mowing. Brush extensions provide a larger sweep area and are hinged to float over uneven areas. They come with weight racks to reduce vibrations and help follow undulations.

Order information:

- 3246** Drag Brush, Size: 108"X26"(274cmX66cm)
- 32461** Drag Brush without the extension, Size: 54-1/2"X26"(138cmX66cm)
- 32462** Two Extension section, Size: 27"X26"(68.5cmX66cm) each

DRAG MAT

Used to spreads dressing material over the green and for the shaping of fairways. The metal net can be fully electro galvanized or stainless steel material to resist rust.

Order information:

- 32551** Galvanized steel Drag Mat 36"X60"(91.5cmX152.5cm)
- 32554** Stainless steel Drag Mat 36"X60"(91.5cmX152.5cm)
- 32553** Galvanized steel Drag Mat 60"X84"(152.4cmX213.4cm)
- 32556** Stainless steel Drag Mat 60"X84"(152.4cmX213.4cm)

HAND OPERATED BRUSH

Easily be used to mow the places which dragon brush hard to reach. Durable brush head with aluminium handle or fiberglass handle.

Order information:

- 3254** Hand Operated Brush fiberglass handle

LEVELAWN

The levelawn effortlessly distributes application materials, removes stones from soil, breaks up small clods of sand or loam and smooths soil for planting.

Size: 30"(76cm) Wide, 68"Handel(173cm)

Weight: 1.9 kg

Order information:

- 3247** Levelawn

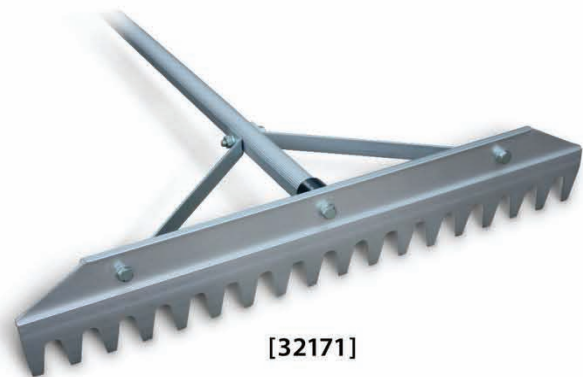

[32171]



[32872]

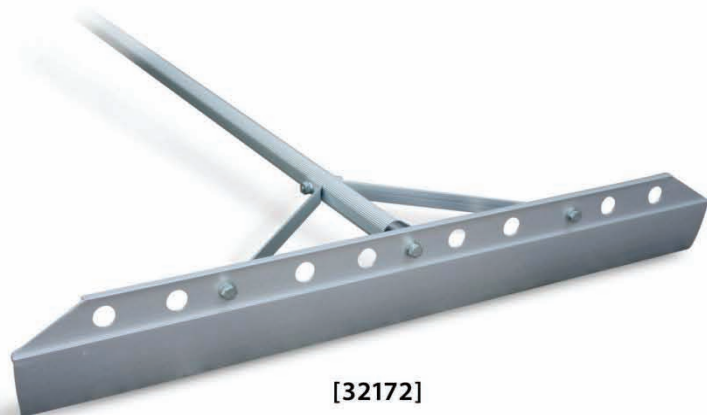

[32172]

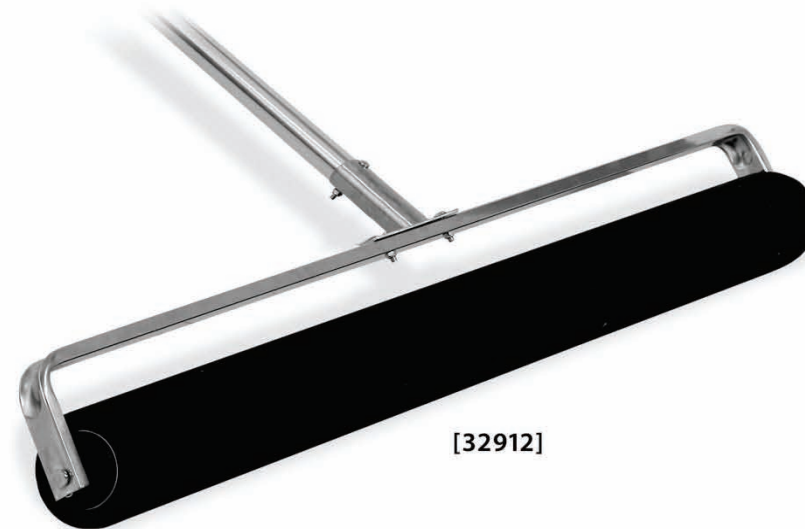

[32912]

MAINTENANCE RAKE

18 teeth 24"(61cm) long aluminium head and 72"(183cm) handle, ideal for construction and repair work.

Order information:
32171 Maintenance rake

PLUG RAKE

31-1/2"(80cm) long aluminium head and 72"(183cm) handle. Light weight but durable and highly effective. Ideal for screening sand or top dressing or for collecting and removing coring plugs.

Order information:
32172 Plug rake

LANDSCAPE RAKE

Long rounded teeth and striking edge excellent for construction and grading.

36" (91 cm) Landscape Rake with 66" (1.7m) aluminium handle.

Order information:
32872 Landscape rake

ROLLER SQUEEGEE

Idea for removing water from greens and turf. Efficient, non-absorbent squeegee features a heavy-duty stainlesssteel frame.

36"(91cm) head with 56"(143cm) aluminium handle.

Order information:
32912 Roller Squeegee



[3262]

[3261]



[3248]



[3290]

ALUMINIUM SCOOP SHOVEL

These high quality aluminium shovels have specially tempered blades with straight cutting edges, thick-waled fiberglass handles with vinyl grips, or with poly D-grips. Scoop size: 15"X20"(38cm x 50.8cm)

Order information:

- 3261** Aluminium scoop shovel with Vinyl grip
- 3262** Aluminium scoop shovel with poly D-grip

LEAF RAKE

Heavy duty spring action, 22 style teeth, and fiberglass handle.

Order information:

- 3248** Leaf rake

CIRCULAR HEAD CUTTER

NEW

This efficient tool is ideal for cutting around sprinkler heads, distance markers and drains. Two pieces (handle + head) construction, one handle works with variety of head sizes. Interchangeable heads are available in 5" to 11" diameters.

Order information:

- | | |
|---------------------------|----------------------------|
| 32900 Handle only | 32908 8" Head only |
| 32905 5" Head only | 32909 9" Head only |
| 32906 6" Head only | 32910 10" Head only |
| 32907 7" Head only | 32911 11" Head only |



[3441]



[3442]



[3446]

CADDIE HEADCOVER

This plastic, high impact resistant headwear is a great safety item for caddies and come in a wide range of colours.

Order information:

- 3441A** Red
- 3441B** Yellow
- 3441C** Blue

CADDIE BIBS

A wide range of colours materials and designs are available. Customized designs are also available and welcomed. Simply send us your pattern, logo, picture or information and we will do the rest.

Order information:

- 3442** Caddie Bibs

CADDIE SUITS

Made of waterproof soft, lightweight and stretchy polyurethane material that can flexes with your movements. Suit is cut full and remains soft in cold weather. Custom LOGO available.

Order information:

- 3446A** Yellow
- 3446B** Blue

BAG RAINCOVERS

Made of various durable 100% waterproof material. Ideal to protect all sizes golf bags against rain or dirt. Top cover is a double-layer design, can be imprinted with your LOGO or any other information.

Order information:
36411 Transparent
36412 Black

HAND SCOOPS

Cast aluminium for light weight and prevention of rust.

Order information:
34451 8 OZ hand scoop (236ml)
34452 10 OZ hand scoop (296ml)
34453 4 OZ hand scoop (120ml)
34454 3 OZ hand scoop (88ml)
34455 2 OZ hand scoop (60ml)

SAND BAGS

Customers always want to have their own style sand bags, we try our best to meet their requirement. You can see that almost each one is different. That's true, we can also customized one for you. Just let us know what you want, or select the sample style to make a little change, it's quite easy to do.

Order information:

34SB-xx
 (please select style number, or design your own sand bag and let us to make.)



[3641]

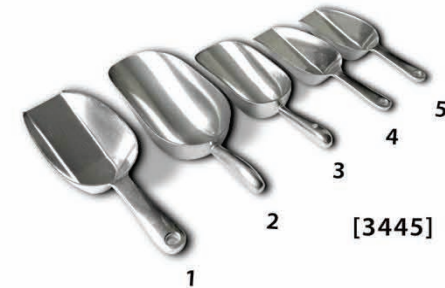

[3445]



[SB-02]

[SB-03]

[SB-04]

[SB-05]



[SB-06]



[SB-07]



[SB-08]



[SB-09]

[34SB]



[35101]



[3511]



[35100]

You just need to supply your thoughts, let us do the rest.

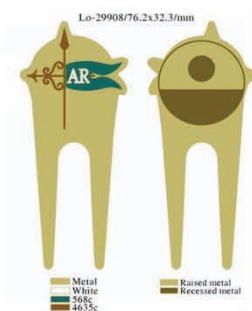

PLASTIC DIVOT TOOL

Plastic divot tools are silk screened with your logo and sold in bulk. Many colours available, simply enquire.

Order information:
35101 Plastic Divot Tool

PARSETT METAL DIVOT TOOLS

Material: Zinc alloy, length:11 cm

Order information:
35100 Parsett metal divot tool

PLASTIC BALL MARKER

Colourful golf ball markers are available in a range of colours that can also be customized with your logo imprinted on the surface. Minimum orders to apply.

Order information:
3511 Plastic Ball Marker

CUSTOMIZED METAL BAG TAGS, DIVOT TOOLS AND MONEY CLIP

Gold or silver treated alloy metal material to provide an outstanding finish and super durability. Customized designs are available and welcomed. Simply send us your pattern, logo, picture or information and we will do the rest.

Order information:
35CBT Customized bag tags
35CDT Customized divot tools
35CMC Customized money clip

REGULAR WOODEN TEE

Please specify the product number in the order form when purchasing.
 Material: Wood
 Package: 10,000pcs/ poly bag /carton
 Minimum quantity: 100,000pcs
 Measurement: 53X24X30cm
 Gross weight: approximate to 10Kgs

Order information:
3501 Wooden Tee
 (Please specify color when ordering)

STEP WOODEN TEE

The step tees are great for ensuring your tee height is consistent and are available in three heights. Please specify the product number in the order form when purchasing.
 Material: Wood
 Package: 10,000pcs / poly bag /carton
 Mini. Quantity: 100,000pcs
 Measurement: 53X24X30cm
 Gross weight: approximate to 10Kgs

Order information:
3502 Step Wooden Tee
 (Please specify color when ordering)

IMPRINTED WOODEN TEES

These premium golf tees are imprinted with your message and are available in a wide range of designer colours.
 Please specify the tee colour as well as the imprint colour when ordering.

Order information:
3503 Wooden Tee



	4.2cm	4.8cm	5.4cm	6.0cm	7.0cm	8.0cm	9.0cm
Nature	35011	35012	35013	35014	35015	35016	35017
Assorted	35011M	35012M	35013M	35014M	35015M	35016M	35017M

[3501]



Size	3.5cm	5.4cm	7.0cm
Nature	35021	35022	35023
Assorted	35021M	35022M	35023M

[3502]



[3503]



[3531]



[3532]



[3533]



[35381]



[35382]



[35383]

WOODEN PENCIL WITH ERASER

Length: 10cm
Colours: Nature, Red, yellow, green and blue
Package: 4000pcs/carton.

Order information:

- 3531A** - Red
- 3531B** - Yellow
- 3531C** - Green
- 3531D** - White
- 3531E** - Nature

WOODEN PENCIL WITHOUT ERASER

Length: 9cm
Colours: Red, yellow, green and blue, nature
Package: 4000pcs/carton.

Order information:

- 3532A** - Red
- 3532B** - Yellow
- 3532C** - Green
- 3532D** - White
- 3532E** - Nature

PLASTIC PENCIL

Length: 10cm
Colours: Red, yellow and green/white
Package: 4000pcs/carton.

Order information:

- 3533A** - Red
- 3533B** - Yellow
- 3533C** - Green
- 3533D** - White

SCORE CARD HOLDERS

Made from genuine leather these score card holders have an outstanding stylish appearance. Customized designs are available and welcomed. Simply send us your pattern, logo, picture or information and we will do the rest. A wide range of colours and designs are available.

Order information:

- 3538A** Red
- 3538B** Green
- 3538C** Black